

OutBack Power Systems

MATE

System Controller and Display

Installation and User Manual for the OutBack MATE and MATE2

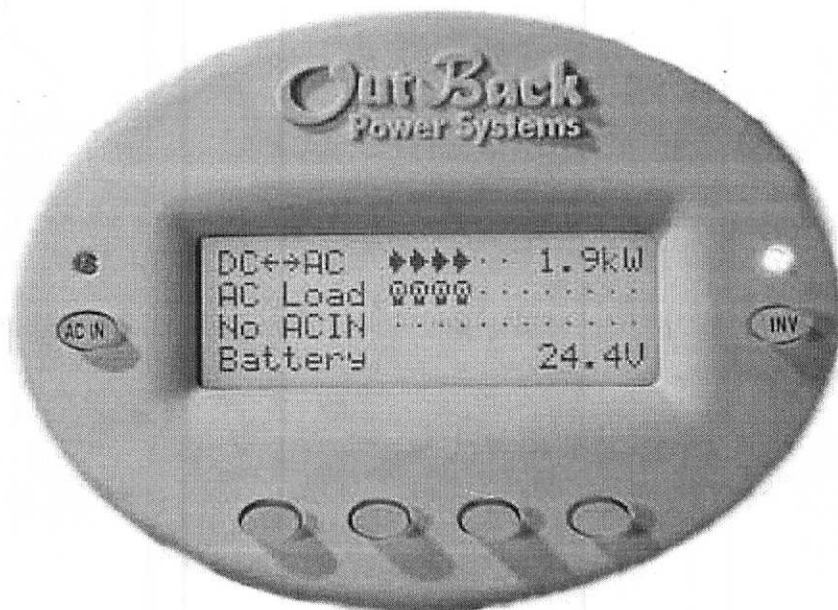

Please check our website at www.outbackpower.com for the latest product information

1.0 INTRODUCTION	4
1.1 FEATURES	4
1.2 INSTALLATION	5
2.0 BASIC OPERATION	5
2.1 POWER UP	5
2.2 NAVIGATION	6
2.2.1 Menu Structure	6
2.2.2 Mate Buttons	6
2.2.3 'SOFT' Keys	7
2.2.4 The 'INV' Hot Key	8
2.2.5 The 'AC IN' Hot Key	8
2.3 COMMON SCREENS	10
2.3.1 The Main Screen	10
2.3.2 Summary Screens	10
2.3.3 Status Screens	11
2.3.4 Setup Screens	11
2.3.5 Advanced Screens	11
2.4 USING THE MATE WITH A HUB	13
3.0 MATE SETUP	14
3.1 SETTING THE CLOCK	14
3.2 CONTRAST ADJUSTMENT	14
3.2 BACKLIGHT ADJUSTMENT	14
3.3 SUMMERY SCREEN OPTIONS	15
3.4 COMMUNICATIONS OPTIONS	15
4.0 MATE CONTROL MODES	15
4.1 HBX MODE	16
4.2 GRID-USE MODE	17
4.3 ADVANCED GENERATOR START MODE	19
4.3.1 AGS Setup	19
4.3.2 Quiet Time	20
4.3.3 Voltage Start	20
4.3.4 Load Start	21
4.3.5 Must Run	21
4.3.6 Exercise	22
5.0 MENU MAP	23
6.0 MENU MAP OVERVIEW	37
7.0 TROUBLESHOOTING	39
REGISTER YOUR PRODUCTS!	41

1.0 Introduction

The OutBack MATE is a complete system controller and display for both the OutBack FX inverter/charger and the MX60 PV MPPT charge controller. It provides a display of the operation as well as allows for control and adjustment of the product setpoints. The OutBack MATE also coordinates the operation of the entire system to maximize the performance and to prevent multiple products from conflicting.

Through the use of an OutBack HUB communication manager a single OutBack MATE is able to connect to multiple FX inverter/chargers, MX60 PV MPPT charge controllers and any other OutBack products offered in the future. A maximum of ten OutBack products will be able to be connected to a single MATE via a HUB using CAT 5 type Ethernet cabling with 8 wire RJ45 modular connectors.

1.1 Features



LCD Display

Four line, 80 character backlit LCD display with alphanumeric and graphic displays

Control Keypad

Six backlit silicone membrane keys – dedicated Inverter and AC input “hot” keys for control & 4 soft keys

Status Indicators

Two LED indicators: *Green* = Inverter status *Yellow* = AC Input status

Communication Protocol

Proprietary OutBack Multi-drop network using the OutBack HUB.

Interconnecting Cable

Standard CAT 5 PC network cable with RJ45 modular connectors / wired as non-crossover

Maximum Cable Length

The maximum distance that has been tested is 1000 feet of cable in an office / commercial building with success.

PC computer interface

RS232 Opto-Isolated DB9 serial communication port

1.2 Installation

The OutBack MATE is designed for surface mounting in an Indoor location. Keep the MATE out of direct sunlight to make the display easier to view.

The cabling from the MATE to the FX inverter/charger, MX60 PV MPPT charge controller or HUB is standard CAT5 type computer cable. Standard Ethernet CAT5 cable, can be found at any home improvement or computer store. Consult your local inspector for specific installation requirements. The current and voltage in the communication cable is limited to less than 30 volts DC and is considered to be a "limited energy circuit". No conduit should be required. Either CAT5 or CAT5e cable can be used. The MATE is shipped with 50' of cable with the correct RJ45 connectors already installed. Longer or shorter cables can be purchased pre-made or custom length cable can be made on site. Follow the cable manufactures' instructions when choosing connectors and crimping tools.



NOTE: The maximum tested cable length from the MATE to an OutBack product is 1000 feet (300 meters). This distance can vary depending on cable routing and location. MATE cable that is run in a 'noisy' environment (ex. MATE cable run in conduit with AC wiring) will suffer from signal degradation, impacting the maximum length the cable can be run without incurring transmission errors.

The MATE should be wall mounted at just below the eye level of the typical user. No wiring box is required, although a standard 2 gang wiring box mounted in the horizontal position (as opposed to the typical vertical position of a light switch) can be used for the cable entry. By bending the wiring at a 90 degree angle just after the connector, no wiring will be visible. The RS-232 port for the PC computer is accessible from the bottom of the MATE when it is wall mounted. It also can be removed from the wall for connection of the serial cable.

To install the MATE, unsnap the cover from the back of the MATE. There are four holes in this plate for mounting screws. After installing the mounting plate on the wall, connect the cable to the jack on the back of the circuit board. Snap the MATE onto the mounting plate and push any excess cable back into the wall.

2.0 Basic Operation

2.1 Power Up

As soon as the MATE cable is plugged into a powered OutBack product, the MATE will power-up and display several information screens. After a greeting and copyright screen appears, the next screen displayed has the MATE Code and Screen Revisions (see below).

Version Code <i>a.aa</i> Serial #xxxxxxx Screen EE <i>b.bb</i>

The MATE's operation and features are dictated by the code version. The serial number displayed matches the bar coded sticker on the MATE's main PCB. This can be viewed by removing the MATE's back cover. The Screen EE version refers to the menu system currently loaded in the MATE. All of the version and serial numbers should be referred to when contacting OutBack with MATE questions.

For an explanation of the differing code versions, see the **MATE firmware revisions** topic under **MATE Release Notes** on the **OutBack Power Systems User Forum** found at: <http://www.outbackpower.com/cgi-bin/Forum/ultimatebb.cgi>.

After the Version screen the MATE will display a connected devices screen (see below). If the MATE does not find the connected device, refer to the section [7.0 Troubleshooting](#).

MATE found an FX

Searching for Devices FX Found

MATE found a MX

Searching for Devices MX Found

MATE found no OutBack Product

Searching for Devices No Devices Found
--

2.2 Navigation

This section of the manual will cover how to use the buttons on the MATE to navigate the menus.



NOTE: The menu system displayed on the MATE will vary depending on the software version that the MATE was programmed with at the time of manufacturing or during its last software upgrade.

2.2.1 Menu Structure

The OutBack MATE uses a branching menu structure to display various OutBack products operation modes and status. The menus are divided by product type and are categorized by type of settings or information is being displayed.

An example of the menu structure is shown to the right. All the screens that show AC meters are grouped together in one menu tree allowing the user to find the required meter with a minimum of button presses.

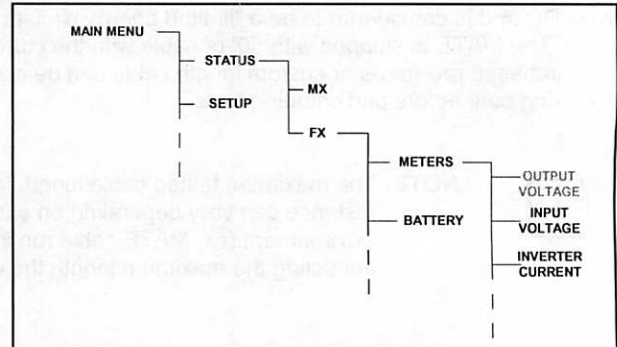

The top line of the MATE display will show the 'path' to the current menu; in this example it is STATUS/FX/METERS.

```
STATUS/FX/METERS-----
output          122 vac
voltage
DOWN UP TOP PORT
```

2.2.2 Mate Buttons



The MATE uses a six button user interface to navigate the menus and to change setpoints of various OutBack products.

Two buttons are dedicated for the FX inverters and are labeled **ACIN** and **INV**. These buttons are special in that they can be pressed at any time anywhere in the MATE menu structure, and they take you to the same screens. For this reason they are referred to as 'hot' keys. Many common functions that need to be accessed often are found under the **ACIN** and **INV** button.

The four lower buttons under the LCD are called 'soft' keys and are used for navigating around the menus and changing values. Each 'soft' key has various functions dependent on the label directly above it on the lower line of the LCD.



NOTE: The lower line on the MATE is almost exclusively used for labels to the four soft keys below. This manual will denote soft key button presses as <BUTTON>, where **BUTTON** corresponds with the label displayed on the screen directly above the soft key.

2.2.3 'SOFT' Keys

The four buttons under the LCD are referred to as the 'soft' keys. Their operation is dependent on what their label says. The label is the word on the bottom line of the LCD directly above the button.

Soft keys used to navigate the menus are commonly labeled <UP>, <DOWN>, <NEXT>, <BACK>, or <TOP>.

Soft keys that change settings are labeled either with the change they will make, such as : <OFF>, <AUTO>, and <ON>, or if there are more than a couple values that the setting can be changed to, <INC> and <DEC> are used to mean *increase* and *decrease*, respectively.

```
SETUP/FX/INPUT---P00
ac transfer      GRID
control
DOWN  GRID GEN  PORT
```

In this example, pressing <DOWN> will take you to the next setpoint screen in the SETUP/FX/INPUT menu.

```
SETUP/FX/INPUT---P00
Input setup
completed
      TOP  SETUP  MAIN
```

In this example, pressing <TOP> will take you to the first setpoint screen in the SETUP/FX/INPUT menu. <SETUP> will return you to the SETUP/FX screen, and <MAIN> will take you back to the Main screen.

```
SETUP/FX/INPUT---P00
ac transfer      GRID
control
DOWN  GRID GEN  PORT
```

In this example, pressing <GRID> will change the FX AC transfer control to GRID mode. Conversely, pressing <GEN> will change the FX AC transfer control to GEN mode.

```
SETUP/FX/INPUT---P00
ac1/grid        60 aac
limit
DOWN  INC  DEC  PORT
```

In this example, pressing <INC> or <DEC> will change the numerical value of the ac1/grid limit setting.

```
ADV/FX/AUX-----P00
aux output      Remote
function
DOWN  INC  DEC  PORT
```

In this example, there are multiple operating modes for the aux output function. Pressing <INC> or <DEC> will cycle through the available modes.

2.2.4 The 'INV' Hot Key

The OutBack MATE includes an **INV** "hot" key to allow direct control of the inverter from anywhere in the menu system. The **INV** key is located on the right side of the MATE LCD display. Pressing the **INV** key will take you to the **INVERTER CONTROL** menu section as shown below.

A green LED indicator is located above the **INV** key which flashes when the inverter is either in the search or power save modes, and is on continuously when full AC output voltage is available from the inverter. When the inverter is turned off or when the AC input source is being used, the green LED will not be illuminated.

When an OutBack HUB is employed, the **INVERTER CONTROL** options effect all FX inverters on the HUB.

INV

INVERTER CONTROL	
currently:	ON
OFF	SRCH ON OK

- <OFF>** Turns all the inverters connected to the MATE off
- <SRCH>** Causes the inverter to begin operating in the search mode if the AC load connected is smaller than allowed by the programming of the search function.
- <ON>** Turns all the inverters connected to the MATE on
- <OK>** Returns to the point in the menu system where you entered the **INVERTER CONTROL** screen

2.2.5 The 'AC IN' Hot Key

The OutBack MATE includes an **AC IN** "hot" key to allow direct control of the AC input from anywhere in the menu system. The **AC IN** key is located on the left side of the MATE LCD display.

Above the **AC IN** key is a yellow LED indicator which flashes when an AC source is available but not connected and which is on continuously when the AC source is connected and in use. If no AC source is connected the yellow LED indicator will remain off.

AC IN

AC INPUT CONTROL	
currently:	USE
DROP	USE OK

Pressing the **AC IN** key once brings up the **AC INPUT CONTROL** screen. This screen allows the user to select whether the FX inverters connect to the AC input source. When an OutBack HUB is employed, the **AC INPUT CONTROL** only effects the Master FX connected to PORT 1. The Master then echoes the command to all of its slaves.

- <USE>** Enables the inverter to connect to the AC source when it is available
- <DROP>** Disconnects the AC input source but will allow it to be reconnected if the battery gets low or the inverter is overloaded
- <OK>** Returns to the point in the menu system from you entered the **AC INPUT CONTROL** screen

Continued on next page

AC IN AC IN

GEN START CONTROL
Currently: Auto
OFF AUTO ON OK

Pressing the **AC IN** key a second time brings up the **GEN START CONTROL** screen. This screen allows the user to change the Advanced Generator Start (AGS) mode. Modes can only be changed when Advanced Generator Start is enabled (See section 4.3 Advanced Generator Start for more information). When an OutBack HUB is employed, the **GEN START CONTROL** only effects the FX that has been programmed as the AGS PORT in the AGS menu.

- <OFF> Manually overrides AGS mode and shuts off the generator
- <AUTO> Allows the MATE to automatically start and stop the generator according to the settings programmed in the AGS menu
- <ON> Manually overrides AGS mode and starts the generator
- <OK> Returns to the point in the menu system where you entered the **GEN START CONTROL** screen

AC IN AC IN AC IN

CHARGER CONTROL
currently: OFF
OFF AUTO OK

Pressing the **AC IN** key a third time brings up the **CHARGER CONTROL** screen. This allows operation of the battery charger to be preset for when an AC source is available. The charger's operation is independent of the inverter: you can set the charger to come on when AC is available but have the inverter stay off when AC is disconnected. When an OutBack HUB is employed, the **CHARGER CONTROL** only effects the Master FX connected to PORT 1. The Master then echoes the command to all of its slaves.

- <OFF> Disables all charger functions in the FX
- <AUTO> Enables automatic battery charging when an AC input source is connected
- <OK> Returns to the point in the menu system where you entered the **CHARGER CONTROL** screen

AC IN AC IN AC IN AC IN

CHARGER MODE CONTROL
Global charger mode
BULK EQ OK

BULK CONTROL
START STOP OK

CHARGER MODE CONTROL
Global charger mode
BULK EQ OK

Pressing the **AC IN** key a fourth time brings up the **CHARGER MODE CONTROL** screen. This screen allows the MATE to issue system wide (global) charger commands. Both OutBack MX and FX products will respond to global charger commands.

Pressing **<BULK>** brings up the **BULK CONTROL** screen, it will allow the user to start and/or stop a bulk charge cycle manually by pressing **<START>** or **<STOP>** respectively.

Pressing **<EQ>** brings up the **EQUALIZE CONTROL** screen.

When the **<START>** has been selected, two informational screen are displayed. The user then must answer **<YES>** before an equalize charging cycle is allowed to begin.

Once the equalizing process has started, you can stop it at anytime by selecting **<STOP>** from this same control screen.



NOTE: For a global charger command to work, all of the OutBack products must be connected to a HUB. The **CHARGER MODE CONTROL** effects both FX inverters *and* MX60 charge controllers. This requires that the FX and MX firmware versions support this feature (See section 7.0 Troubleshooting if this command fails to function).

2.3 Common Screens

2.3.1 The Main Screen

```

MAIN-----
                12:00:30P

SUM STATUS SETUP ADV
  
```

After the power-up screens is the Main screen. It is the root, or home screen to the entire menu structure. If you get lost exploring the MATE's many screens, press the two left soft keys *simultaneously* to return to the Main Screen from anywhere in the menu system. Additionally, most menu branches end with a soft key labeled <MAIN>; pressing this button will return you to the Main screen.

2.3.2 Summary Screens

The Summary screens provided by the MATE summarize the current status of all the OutBack products connected to it. Summary screens can be accessed from the Main screen by pressing the <SUM> button or can be set to pop up like a screen saver after a delay (See section 3.3 Summary Screen Options for more setup information). Any MATE button pressed while the Summary screen is being displayed returns you to the screen that was active before the summary screen was displayed.

If the MATE has one or more FXs connected to it, an FX summary screen will be displayed. It shows three bar graphs that summarize power flow in an FX system. Each bar graph is made up of segments that roughly represent 500 watts of power per FX inverter connected (ex. With 2 FXs, each segment would represent 1000 Watts).

```

DC<>AC ..... 0.0kw
AC Load .....
Buying .....
Battery                25.6V
  
```

```

DC<>AC >>>... 1.5kw
  
```

The DC<>AC bar graph represents the amount of power conversion happening in the system. It could be either the FX's inverting and supplying AC power to the loads, or the FX's charging the batteries with an AC input source. There is also a numerical read-out (in kilowatts) in the upper right hand corner.

```

AC Load ☀☀☀.....
  
```

The AC LOAD bar graph shows the amount of power that the FX is sending out its AC OUTPUT to power loads. This bar graph should equal the DC<>AC bar graph when all the FXs in a system are inverting and will equal pass-thru loads when all the FXs are connected to an AC source.

```

Buying    $$$$$.....
  
```

The next bar graph denotes the power coming in or going out of the AC input terminals of the FX. Its label can be Buying when the AC input source is providing power to the FX and loads or Selling when the FX is exporting excess battery capacity back to the Grid.

```

Battery    26.5V
  
```

The last line is for displaying battery voltage.

If the MATE has one or more MX60 MPPT charge controllers attached to it, an MX summary screen will be displayed. Each arrow displayed on the MX summary screen is equal to 500 watts per MX (ex. With 3 MXs, each arrow would represent 1500 watts).

```

-----
MX CHARGER  1.5kw
>>>.....
Battery                25.6V
  
```



NOTE: A MATE connected to a HUB with both FXs and MXs connected to it will switch between both types of summary screens every 20 seconds.

2.3.3 Status Screens

The Status menu that can be accessed by pressing **<STATUS>** on the Main screen contains all the meters and mode displays for OutBack products that are connected to the MATE.

```

MAIN-----
                12:00:30P
SUM STATUS SETUP ADV
    
```

The Status menu is divided first by product; then it is further divided into menu categories, such as meters, modes, and statuses.

```

STATUS-----
Choose product:

FX   MX
    
```

The Status screens available differ by product type and revision. (See section [5.0 Menu Map](#) for locations of all of the status screens available.) Consult your specific OutBack product owner manual for an explanation of all the operating modes and meters.

```

STATUS/FX/PAGE1-----
Choose category:

MODES METER BATT PG2
    
```



NOTE: Not all Status screens are applicable to all FX models. An example would be; none Grid-Tie FX may not display grid-tie parameters.

2.3.4 Setup Screens

The Setup screens allow the user to adjust basic setpoints for the MATE and FX inverters. Changing Setpoints in the MX60 is not supported via the MATE at this time. Pressing **<SETUP>** from the Main screen allows the user to choose the FX or the MATE setup menu.

```

MAIN-----
                12:00:30P
SUM STATUS SETUP ADV
    
```

MATE Setup will be covered in section [3.0 MATE Setup](#).

The FX Setup menu will allow the user to change Search and Input settings only. Refer to the FX user manuals for an explanation of these settings and their functions.

```

SETUP/FX-----
Choose category:

SRCH  INPUT    MAIN
    
```

2.3.5 Advanced Screens

The Advanced menu system is where most of the initial system settings are programmed. Because changing these settings could adversely effect how the system operates, the user must input a password to enter the advanced menus. The settings under the Advanced menu should only be changed by someone that has read and understands the specific products (FX or MX) users manual.

The Advanced menus can be accessed by pressing the **<ADV>** from the Main screen. Pressing **<ADV>** brings up a warning screen. Pressing any of the soft keys at the warning screen will bring the user to the password screen.

```

MAIN-----
                12:00:30P
SUM STATUS SETUP ADV
    
```

Using the **<INC>** or **<DEC>** buttons changes the number displayed to match the Advanced menus password. When the password is set, press **<ENTER>** to go into the Advanced menu. Pressing **<EXIT>** will return the user to the Main screen.

```

ADV/PASSWORD-----
Enter the password
                132
ENTER  INC  DEC  EXIT
    
```

The Advanced Menu Password is 141

2.3.5 Advanced Screens cont.

The Advanced menus allow the user to set most of the initial system setpoints for the FX, MX, and MATE. After entering the password choose the product you would like to change the Advanced settings for.

The FX Advanced menus have categories like:

- INV – Inverter setup
- CHGR – Charger setpoints
- GRID – Grid input setpoints
- GEN – Generator input setpoints
- AUX – FX Aux output settings
- STACK – FX stacking setup
- SELL – Grid-Tie setup
- CAL – FX meter calibrations



NOTE: Not all Advanced menu screens are applicable to every model FX. An example would be a non Grid-Tie FX may not display grid-tie parameters, or allow their adjustment.

The MX Advanced menus only allow for the setup and control of the MX60s AUX output.

The Mate Advanced menus contain the settings for:

- HBX – High battery transfer
- GRIDUSE – Time of day grid usage
- AGS – Advanced generator starting

These advanced settings are covered in section 4.0 Mate Control Modes

2.4 Using the MATE with a HUB

A HUB-4 or HUB-10 can be used to connect multiple OutBack products to the MATE. A HUB-10 communication manager allows a single MATE to control and monitor a maximum of ten OutBack products, while a HUB-4 is limited to four OutBack products.

A HUB has 4 to 10 ports labeled 1-10 for various OutBack products to be plugged into.

When setting-up a HUB based system to work with the MATE, several guidelines must be followed:

A system comprised of all FX inverters must have the Master FX plugged into Port 1 of the HUB.

A system comprised of all MX charge controllers must have one of the MXs plugged into Port 1.

A system that has a mix of FXs and MXs must have the Master FX plugged into Port 1 and have the slave FXs plugged into the next lowest numbered Ports. For example, if a system comprised of 4 FX's and 2 MX's, the FXs must be plugged into Ports 1 – 4; the MXs can be plugged into any Port numbered greater than 4.

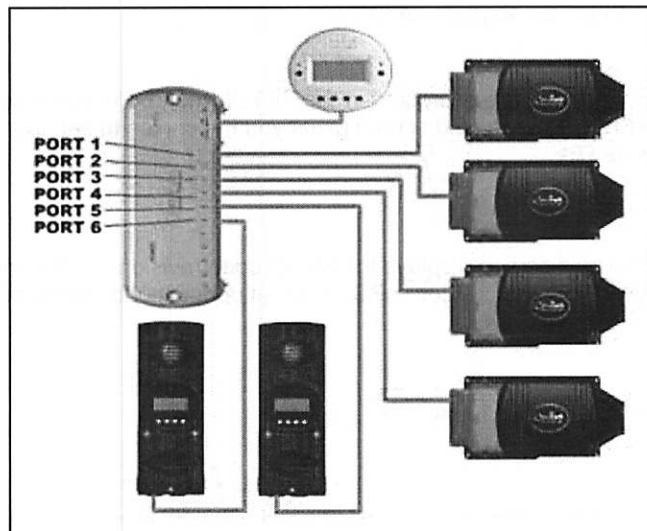

When first powering-up the system, make sure all of the OutBack products are plugged into the HUB and powered before plugging the MATE into the HUB.

When a MATE that is plugged into a HUB powers up, it will first display that it has found the HUB.

Searching
for Devices
HUB Found

Next it will display the Port Assignment screen. This screen shows all of the connected devices and what Port that they are found on. If a connected device is not shown on this screen, check that it is connected correctly and is powered up. Then either unplug and plug the MATE back into the HUB or use the REPOLL command described in the [MATE Setup](#) section to force the MATE to rediscover all devices.

Port Assignment			
1>FX	2>FX	3>FX	4>FX
5>MX	6>MX	7>--	8>--
9>--	10>--	2M>--	

Once powered up, the MATE operation with a HUB is basically the same as when the MATE is directly connected to an OutBack product.

STATUS/FX/METER-----P01
Output 120vac
Voltage
DOWN UP TOP PORT

The most important difference is the Port Identifier in the upper right hand corner of most screens. The number after the P in P01 tells you that the meter reading currently displayed on the screen is coming from the FX in Port 1. By pressing the <PORT> button, you can cycle through all of the devices on the system.



NOTE: When the user is in a menu that is dedicated to FXs, only FX Ports can be cycled through by pressing the <PORT> button. Using the above system as an example, only P01, P02, P03, and P04 will be displayed when the <PORT> button is pushed while in a FX menu. Conversely, only P05 and P06 will be displayed when the <PORT> button is pressed in an MX menu.



NOTE: Any time a new device is plugged into a HUB or an existing device is moved to a different Port, the MATE must be either unplugged and plugged back into the HUB or the REPOLL command described in the [MATE Setup](#) section must be used to force the MATE to rediscover all devices.

3.0 MATE Setup

This section will take you through the MATE specific setup, allowing you to change the display settings, set the Mates clock, and set various MATE control settings.

Besides the clock display, the Main screen has four menu choices that correspond with the four soft keys under them.

For now we are interested in the SETUP menu. Press the soft key under the word <SETUP>. The next screen gives you the choice to set up a FX or the MATE; choose <MATE>.

The next screen displays the MATE code revision (3.00 in the example to the left) and several Setup choices. <PG2> brings up a second screen of Setup choices.

```
MAIN-----
                12:00:30P
SUM STATUS SETUP ADV
```

```
SETUP-----
Choose product:
FX                      MATE
```

```
SETUP/MATE/PAGE1-----
Mate code rev:          300
Choose category:
CLOCK CNT GLOW PG2
```

```
SETUP/MATE/PAGE2-----
Choose category:
PG1 SUMRY COMM MAIN
```

3.1 Setting the clock

Pressing <CLOCK> lets you choose to change the date and/or time displayed by the MATE. The <BACK> button returns you to the previous screen. Correct time and date are required for the Mate Control Modes discussed in section 3.0 to operate correctly.

```
SETUP/MATE/CLOCK-----
Mo 1/01/03
                12:00:00P
BACK DATE TIME
```

3.2 Contrast adjustment

<CNT> sets the desired contrast level. <INC> increases the contrast level, <DEC>; decreases the contrast level. The LCD on the MATE automatically adjusts for most temperature changes, but the contrast might need to be changed for ambient lighting conditions.

```
SETUP/MATE/CNT-----
Contrast:                30%
BACK INC DEC
```

3.2 Backlight adjustment

<GLOW> sets the desired backlight mode, level, and on time. Pressing <GLOW> brings up several more backlight settings.

<LEVEL> controls brightness and is adjustable from 0 to 100%.

<MODE> allows user to set the backlight to always off, auto-off after a time, or always on by selecting <OFF>, <AUTO>, or <ON>, respectively.

<TIME> sets the auto-off time limit from 1 to 60 minutes. This is how long the MATE waits after the last button press to turn off the backlight. Once the backlight has turned off, any button press on the MATE will turn it back on.

```
SETUP/MATE/GLOW-----
Backlight controls
BACK LEVEL MODE TIME
```



NOTE: The MATE clock does not automatically adjust for daylight savings time.

3.3 Summary Screen Options

<SUMRY> brings up Summary screen options.

<TYPE> allows you to choose the type of summary screen(s) displayed. Your choice is: ROLL, FXONLY, MXONLY, or NONE. Roll switches between FX and MX screens automatically if both types of products are connected to the MATE. FXONLY or MXONLY only display the FX or MX summary screen if the respective product is connected. NONE disables the summary screen from popping up automatically, it can still be accessed via the <SUM> button on the Main screen.

SETUP/MATE/SUMMARY--
Summary control

BACK TYPE TIME

<TIME> brings up a delay setting for how long it takes for a summary screen to be displayed. Information on the summary screens is covered in section [2.3.2 Summary Screens](#).

3.4 Communications Options

<COMM> deals with MATE communication options. Pressing <COMM> brings up several options that can be changed.

<REPOLL> forces the MATE to 'rediscover' all the OutBack devices it is connected to. This is used any time an OutBack devices is moved or added to a HUB.

SETUP/MATE/COMM-----
Choose category:

BACK REPOLL PC DEBUG

<PC> will enable or disable the RS232 communications port of the MATE. This setting must be enabled if you use any third party logging or control software.

<DEBUG> allows communications errors involving the OutBack HUB to be tracked.

On the DEBUG screen, first press <RSET> to reset the error counting display; then press <VIEW> to bring up a list of HUB ports with a count of communications errors for each port.

SETUP/MATE/COMM-----
Comm. errors:

BACK VIEW RSET

In the example to the right, Port 4 has a large number of errors detected (04:025 means Port 4: showing 25 errors). Pressing any key will take you to the SETUP/MATE/COMM screen, which will allow the error counts to be reset using the <RSET> button. The DEBUG screen can be redisplayed by using the <VIEW> button, or the user can get back to the SETUP menu by using the <BACK> button.

00:000	01:000	02:000
03:000	04:025	05:001
06:001	07:001	08:001
09:001	10:001	2M:001

Use the information on the DEBUG screen to locate the problem device. Make sure that it's DC breaker is on and that it is operating correctly. Check or replace CAT5 cables running from the HUB to that device.

4.0 Mate Control Modes

The OutBack MATE is capable of several advanced modes of operation. These modes require that the MATE remain connected to at least one OutBack FX inverter at all times. The first two modes automatically use the MATE commands **DROP** and **USE** to allow the FX to connect to an AC input source only at specified times or battery levels.

A manual **USE** or **Drop** command can be issued by pressing the <ACIN> button until the AC INPUT CONTROL screen is reached. <USE> tells the FX to go ahead and use the AC input source while <DROP> will tell the FX to ignore any AC Input source.

The settings for all of the MATE Control Modes are under the ADVANCED menu. From the Main screen press <ADV> and enter the password for access to the ADVANCED menus. Once the ADVANCED menu has been entered, choose <MATE> and you should see a screen similar to the one on the right. At this point you can choose which MATE Control Mode you would like to setup.

ADV/MATE-----
Choose category:

HBX GRIDUSE AGS ADV

4.1 HBX Mode

HBX stands for high battery transfer. It is a mode primarily used in applications that have enough RE power production to meet the needs of the loads most of the time. HBX mode will only allow the FX to connect to an AC source if the battery voltage has fallen below a programmable setpoint for a user configurable amount of time. The MATE will then allow the FX to remain connected to the AC source until the battery voltage has risen above a second setpoint for a programmable amount of time.



NOTE: HBX Mode in a multi-inverter installation utilizing a HUB-4 or HUB-10 will control the Master FX in port 1. The Master will then instruct any stacked slaves to **USE** or **DROP** the AC input source.

HBX-USE GRID SETPOINT: This is the voltage setpoint for when the FX will be allowed to **USE** its AC input source. The battery voltage must remain below this voltage for the amount of time set by **HBX-USE GRID DELAY** for a **USE** to be issued. **<INC>** and **<DEC>** buttons can be used to change the value.

ADV/MATE/HBX-----	
hbx-use	24.0 vdc
grid setpoint	
DOWN	ADV INC DEC

HBX-USE GRID DELAY: This setpoint is the amount of time that battery voltage must remain below **HBX-USE GRID SETPOINT** before a **USE** command is sent. It can range from 00.1 hrs to 24.0 hrs in 0.1 hour increments.

ADV/MATE/HBX-----	
hbx-use	01.0 hrs
grid delay	
DOWN	UP INC DEC

HBX-DROP GRID SETPOINT: This is the voltage at which the FX will be allowed to **DROP** its AC input source. The battery voltage must remain above this voltage for the amount of time set by **HBX-DROP GRID DELAY** for a **DROP** to be issued.

ADV/MATE/HBX-----	
hbx-drop	26.0 vdc
grid setpoint	
DOWN	UP INC DEC

HBX-DROP GRID DELAY: This setpoint is the amount of time that battery voltage must remain above **HBX-DROP GRID SETPOINT** before a **DROP** command is sent. It can range from 00.1 hrs to 24.0 hrs in 0.1 hour increments.

ADV/MATE/HBX-----	
hbx-drop	01.0 hrs
grid delay	
DOWN	UP INC DEC

AC INPUT CONTROL: With this screen, HBX Mode can be enabled or disabled. Pressing **<CHANGE>** allows you to change the current mode.

Before enabling HBX Mode make sure that the FX is in **DROP** mode by pressing **<DROP>**. The screen should indicate **DROP** mode. Enable HBX by pressing the **<HBX>** button. The screen will now indicate that the MATE is running in HBX mode by displaying the current state, **USE** or **DROP** followed by **-HBX**.

To disable HBX Mode, simply press the **<HBX>** button again. After disabling HBX make sure to reset the **DROP** or **USE** to whatever state is desired.

Pressing **<DONE>** returns you to the HBX menu where you can exit back to the **ADVANCED** menu by using either the **<UP>** or **<DOWN>** buttons.

ADV/MATE/HBX-----	
ac input	USE
control	
DOWN	UP CHANGE

ADV/MATE/HBX-----	
ac input	DROP-HBX
control	
DROP	USE HBX DONE



NOTE: Even with HBX mode enabled, the user can issue manual **DROP** or **USE** commands using the **AC INPUT CONTROL** found under the **ACIN** button.

4.2 Grid-Use Mode

Grid-Use mode is for time of day based grid usage. It allows you to program the time of day that the FX will connect to the AC input source. You must ensure that the time and date is properly programmed for Grid-Use mode to function properly (See section [3.0 MATE Setup](#)).

Grid-Use mode will allow the user to choose the time of day that the FX will **USE** the AC input source, and is good for taking advantage of cheaper utility rates during off-peak hours. Grid-Use time can be programmed separately for weekday vs. weekend connect times. Care must be taken when programming weekday and weekend times that encompass USE periods past midnight (12:00 am). The user must take into account weekday USE periods that will end on a Saturday.

Example #1:

Weekday Start 6:00 PM	Weekday Stop 6:00 AM
Weekend Start 12:00 AM	Weekend Stop 12:00 AM

The weekend USE period has been left at its default. Any time that a Start time equals a Stop time, no action will be taken. This results in the time period being ignored. The above settings will have the following results:

Mon – Thr evenings at 6PM the MATE will issue a USE command to the FX allowing the AC input source to be used. Additionally, every morning (Mon – Thr) at 6AM a DROP will be issued. On FRI evening at 6PM a USE will be issued but since the Weekend Start and Stop times are equal, the weekend use time is disabled No DROP will be issued until Mon morning at 6AM.

Example #2:

Weekday Start 6:00 PM	Weekday Stop 6:00 AM
Weekend Start 4:00 PM	Weekend Stop 8:00 AM

Mon – Thr evenings at 6PM the MATE will issue a USE command to the FX allowing the AC input source to be used. Additionally, every morning (Mon – Thr) at 6AM a DROP will be issued. On FRI evening at 6PM a USE will be issued. The following morning is a weekend (Sat) so a DROP command will be issued at 8AM. Sat evening at 4PM the FX will USE again until Sun morning at 8AM. Sun evening at 4PM a USE time period will start, ending on Mon morning at 6AM.



NOTE: If the battery falls below the FX Low Battery Cut-off voltage, the FX will automatically connect to the AC input source regardless of the **GRID-USE** time of day setting.

NOTE: Because **GRID-USE** mode uses the **DROP** and **USE** commands, it cannot be enabled at the same time as **HBX** mode. Enabling **GRID-USE** will automatically disable **HBX** mode.

Grid-Use cont. on next page

GRID-USE ENABLE: This screen actually turns **GRID-USE** mode **<ON>** or **<OFF>**. Make sure that all of the **GRID-USE** parameters are set before enabling **GRID-USE** mode. The **GRID-USE** settings can be accessed by using the **<DOWN>** button.

ADV/MATE/GRIDUSE----- griduse enable: Off DOWN ADV OFF ON

WEEKDAY GRID-USE START: This setting is the time during the week (Mon – FRI) that a **USE** will be issued to an FX, allowing the FX to connect to the AC input source. The time displayed is the current setting. To change the time press **<CHANGE>**.

ADV/MATE/GRIDUSE----- weekday 12:00A griduse start DOWN ADV CHANGE

Using the **<INC>** and **<DEC>** buttons, set the hour to the desired time. Then press **<DOWN>**.

WEEKDAY GRDUSE START Adj hour 12:00A DOWN INC DEC
--

Using the **<INC>** and **<DEC>** buttons, set the minutes to the desired time. Then press **<DONE>**.

WEEKDAY GRDUSE START Adj min 12:00A INC DEC DONE

WEEKDAY GRID-USE STOP: This setting is the time during the week (Mon – FRI) that a **DROP** will be issued to an FX, forcing FX to disconnect from the AC input source. The time displayed is the current setting. To change the time press **<CHANGE>**.

ADV/MATE/GRIDUSE----- weekday 12:00A griduse stop DOWN ADV CHANGE
--

WEEKEND GRID-USE START: This setting is the time during the weekend (Sat & Sun) that a **USE** will be issued to an FX, allowing the FX to connect to the AC input source. The time displayed is the current setting. To change the time press **<CHANGE>**.

ADV/MATE/GRIDUSE----- weekend 12:00A griduse start DOWN ADV CHANGE

WEEKEND GRID-USE STOP: This setting is the time during the weekend (Sat & Sun) that a **DROP** will be issued to an FX, forcing FX to disconnect from the AC input source. The time displayed is the current setting, to change the time press **<CHANGE>**.

ADV/MATE/GRIDUSE----- weekend 12:00A griduse stop DOWN ADV CHANGE
--



NOTE: A Start time that equals a Stop time disables USE time for that period (weekday or weekend).

4.3 Advanced Generator Start Mode

Advanced Generator Start (AGS) Mode utilizes the AUX output found on FX inverters and is compatible with any 2 wire start generator. AGS allows the user to choose a variety of conditions that will start a generator by energizing the FX AUX output.

AGS will start the generator anytime one or more of the Gen Start conditions are true, and will stop the generator only when all of the conditions are false.

After AGS starts a generator, the FX must connect to the generator within a 5 minute window. If the FX fails to connect within 5 minutes, a Genstart error is displayed by the MATE, and all subsequent AGS conditions will be ignored until the AGS mode has been reset. AGS mode can be reset by using the **GEN START CONTROL** found by pressing the **<ACIN>** button twice. Pressing **<OFF>** and then **<AUTO>** resets all AGS parameters. The generator can also be manually started using the **GEN START CONTROL** screen by pressing **<ON>**. If the user wants the generator to auto stop after a charge cycle is complete, the user can press the **<AUTO>** button after the generator has been started by pressing **<ON>**.

The following is a discussion of all the AGS setup parameters and start condition available to the user:

4.3.1 AGS Setup

The AGS Setup menu contains the following general settings that define how the rest of the AGS routines will work:

AGS Port:

The MATE can use any AUX output of an FX that is connected to it either directly or via an OutBack HUB-4 or HUB-10. If a HUB is used, the MATE must be told what Port that the desired FX resides on. If no HUB is used and the MATE is directly plugged into an FX, then the AGS Port needs to be set to 0 (zero). If a HUB is used, the numbered jack that the desired FX is connected to on the HUB should be set as the AGS Port.

```
MATE/AGS/SETUP-----
Ags port:                0
DOWN AGS  INC  DEC
```

Example:

A MATE is connected to a HUB-10 that has four FXs and three MXs connected to it. The FXs are plugged into Ports 1 – 4, as labeled on the HUB, and the MXs are plugged into Ports 5 – 7. The FX connected to Port #3 will have its AUX output wired to the generator, so the AGS Port should be set to '3'.

AGS Control:

This screen allows the AGS mode to be changed. Pressing **<CHANGE>** brings up a screen that allows the user to switch AGS from Manual to Auto.

An **<OFF>** de-energizes the FX AUX output and stops the generator regardless of any AGS setting; this is displayed as MAN – OFF.

An **<AUTO>** will allow the AGS settings to start and stop the generator automatically, and is displayed as either AUTO – ON (when the generator is running), or AUTO – OFF (when the generator is stopped).

An **<ON>** will energize the FX AUX output and start the generator regardless of any AGS setting, this is displayed as MAN – ON.

```
ADV/MATE/AGS/SETUP----
Ags control:            MAN-Off
DOWN UP  CHANGE
```

```
GEN START CONTROL
currently:              MAN-Off
OFF  AUTO  ON  OK
```

AGS Enabled:

This is the overall control for AGS. If AGS is not enabled, none of the AGS settings or controls will work.

```
ADV/MATE/AGS/SETUP----
Ags enabled:            NO
DOWN UP  NO  YES
```

DC Genset:

A Yes means that you have a DC generator and that AGS routines which normally stop the generator upon the FX going to Float or Silent will instead stop the generator when the **VDC Genstop** setting is reached.

```
ADV/MATE/AGS/SETUP----
Dc genset:              NO
DOWN UP  NO  YES
```

VDC Genstop:

This voltage setting will terminate a Voltage Start Genstart when the battery voltage remains above it for 15 min regardless of the **DC Genset** setting.

```
ADV/MATE/AGS/SETUP----
Vdc genstop:           38.0 vdc
DOWN UP  INC  DEC
```

4.3.2 Quiet Time

Quiet Time is a time period during which the MATE will not allow most AGS settings to start the generator. This is usually set-up as night time when a running generator would be an annoyance. Quiet Times can be set individually for weekday and weekend, and consist of a Quiet Time Start and a Quiet Time Stop.

WEEKDAY START:

Weekday Quiet Time start is the beginning of the quiet time period for Mon - Fri, most AGS start conditions will be stopped at this time. Press **<CHANGE>** to adjust the hour and minutes settings.

ADV/MATE/AGS/QT-----
weekday: 12:00A
quiet time start
DOWN AGS CHANGE

WEEKDAY STOP:

Weekday Quiet Time stop is the end of the quiet time period for Mon - Fri. Press **<CHANGE>** to adjust the hour and minutes settings.

ADV/MATE/AGS/QT-----
weekday: 12:00A
quiet time stop
DOWN UP CHANGE

WEEKEND START:

Weekend Quiet Time start is the beginning of the quiet time period for Sat & Sun, most AGS start conditions will be stopped at this time. Press **<CHANGE>** to adjust the hour and minutes settings.

ADV/MATE/AGS/QT-----
weekend: 12:00A
quiet time start
DOWN UP CHANGE

WEEKEND STOP:

Weekend Quiet Time stop is the end of the quiet time period for Sat & Sun. Press **<CHANGE>** to adjust the hour and minutes settings.

ADV/MATE/AGS/QT-----
weekend: 12:00A
quiet time stop
DOWN UP CHANGE

4.3.3 Voltage Start

There are three voltage start setpoints in AGS Mode that the user can adjust. After a generator is started due to a Voltage Start setting, it will be stopped when the FX reaches Float or Silent mode, or based on the VDC Genstop setting in AGS Setup menu previously explained.

24 Hour voltage setpoint:

If the battery voltage falls below this setpoint, a 24 hour timer starts to count down. On reaching zero, a genstart is sent to the FX inverter unless it is currently Quiet Time.

ADV/MATE/AGS/VSTART--
Volt start 24.4 vdc
24 hr setting
DOWN AGS INC DEC

2 Hour voltage setpoint:

If the battery voltage falls below this setpoint, a 2 hour timer starts to count down. On reaching zero, a genstart is sent to the FX inverter unless it is currently Quite Time.

ADV/MATE/AGS/VSTART--
Volt start 23.6 vdc
2 hr setting
DOWN UP INC DEC

2 Minute voltage setpoint:

If the battery voltage falls below this setpoint, a 2 minute timer starts to count down. On reaching zero, a genstart is sent to the FX inverter *even* if it is currently Quite Time.

ADV/MATE/AGS/VSTART--
Volt start 22.0 vdc
2 min setting
DOWN UP INC DEC

4.3.4 Load Start

Load Start will start a generator whenever the total system AC Load exceeds the setpoint for the programmed amount of time. The generator will then be stopped when the AC load has dropped below a Load Stop setpoint for a programmed amount of time.

Load Start KW:

An AGS genstart will be issued when the total AC load of all the FXs connected to the MATE exceeds this setting for the amount of time set with **Load Start Delay**. A zero disables any load start function. <INC> and <DEC> adjusts this setting between 1 – 50kW.

ADV/MATE/AGS/LS-----	
Load start	0 kw
DOWN	AGS INC DEC

Load Start Delay:

This setting is the delay time that the total system AC load must remain above **Load Start kW** , before the generator is started. It is adjustable from 1 to 240 minutes.

ADV/MATE/AGS/LS-----	
load start	1 min
delay	
DOWN	UP INC DEC

Load Stop KW:

An AGS genstop will be issued when the total AC load of all the FXs connected to the MATE fall below this setting for the amount of time set with **Load Stop Delay**. This setting excludes any FX charger current for its AC load calculation. Only when the power being provided to the FXs' AC output falls below this setting, will the generator be stopped.

ADV/MATE/AGS/LS-----	
Load stop	0 kw
DOWN	UP INC DEC

Load Stop Delay:

This setting is the delay time that the total system AC load must remain below **Load Stop kW** , before the generator is stopped. It is adjustable from 1 to 240 minutes.

ADV/MATE/AGS/LS-----	
load stop	1 min
delay	
DOWN	UP INC DEC

4.3.5 Must Run

Must Run Time is a daily time period that the MATE will command the generator to run every day. Must Run Times can be set individually for weekday and weekend, and consist of a Must Run Start time and a Must Run Stop time. Setting Must Run start and stop times to the same time, disables the Must Run function.

WEEKDAY START:

Weekday Must Run start time is the beginning of the time period , Mon - Fri, that the generator will be forced to run. Press <CHANGE> to adjust the hour and minutes settings.

ADV/MATE/AGS/MR-----	
weekday:	12:00A
must run start time	
DOWN	AGS CHANGE

WEEKDAY STOP:

Weekday Must Run stop time is the end of the Must Run time period for Mon - Fri. Press <CHANGE> to adjust the hour and minutes settings.

ADV/MATE/AGS/MR-----	
weekday:	12:00A
must run stop time	
DOWN	UP CHANGE

WEEKEND START:

Weekend Must Run start time is the beginning of the time period , Sat & Sun, that the generator will be forced to run. Press <CHANGE> to adjust the hour and minutes settings.

ADV/MATE/AGS/MR-----	
weekend:	12:00A
must run start time	
DOWN	UP CHANGE

WEEKEND STOP:

Weekend Must Run stop time is the end of the Must Run time period for Sat & Sun. Press <CHANGE> to adjust the hour and minutes settings.

ADV/MATE/AGS/MR-----	
weekend:	12:00A
must run stop time	
DOWN	UP CHANGE

4.3.6 Exercise

An Exercise time can be set by choosing a day of the week (Sun – Sat), a start time of day (12AM – 11:59PM), and a exercise period (1 – 240 minutes). On the first occurrence of the chosen day of the week each month, at the programmed start time, the generator will start and run for the programmed period.

EXERCISE START DAY (exstartday):

This is the day of the week that the generator will start on. This can be set to Mon – Fri, and Sat or Sun, depending on what day each month a generator exercise period should be run. The setting “- -” disables any exercise period.

ADV/MATE/AGS/EX-----
exstartday: --
DOWN AGS INC DEC

EX START TIME:

This setting controls at what time on the **Exercise Start Day** the generator will start it's exercise period. Press <CHANGE> to adjust the hour and minutes settings.

ADV/MATE/AGS/EX-----
Ex start time: 12:00A
DOWN UP CHANGE

EX PERIOD:

Ex Period is how long a generator exercise period will be. <INC> and <DEC> can change the value between 1 – 240 minutes.

ADV/MATE/AGS/EX-----
Ex period: 15 min
DOWN UP INC DEC

5.0 Menu Map

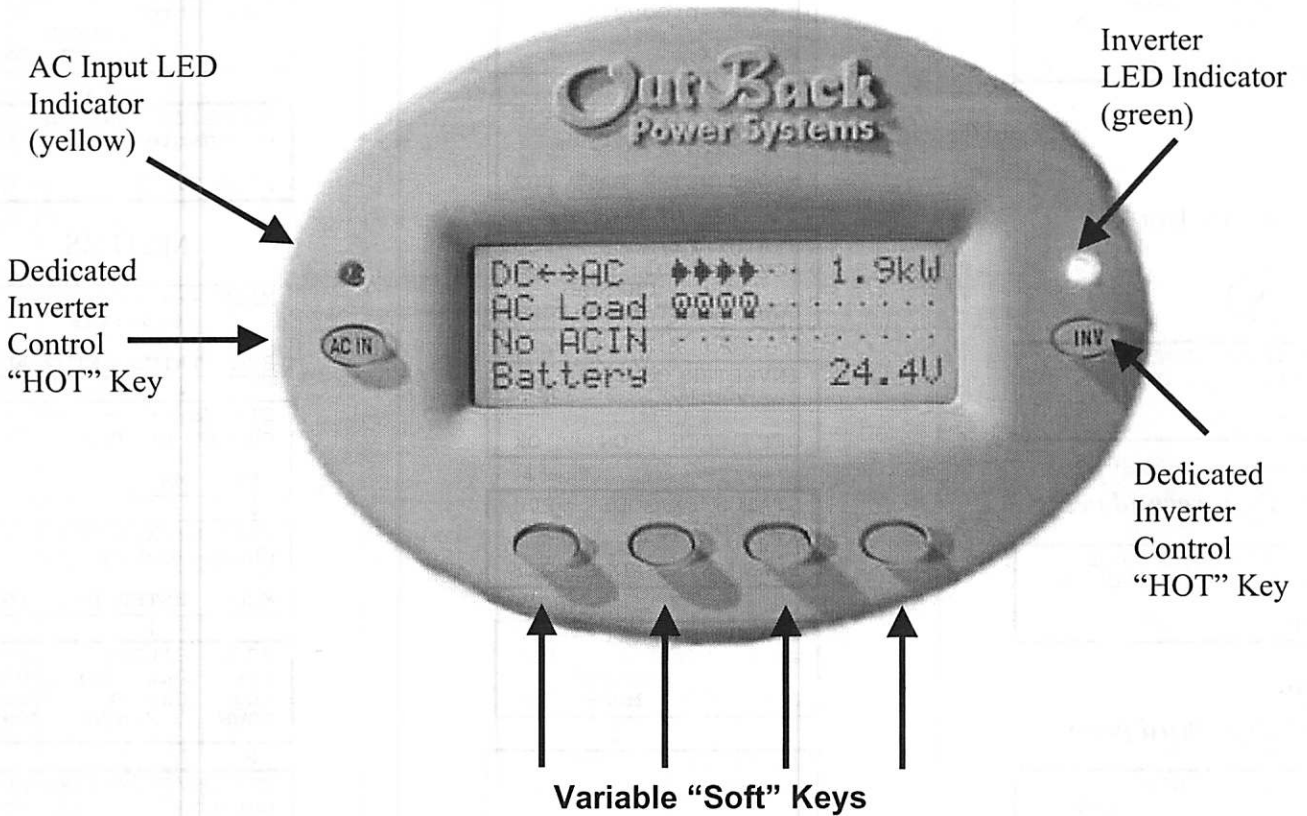

each one of the soft keys corresponds to a word on the bottom line of the LCD display

The menu system displayed on the MATE will vary depending on the software version that the MATE was programmed with at the time of manufacturing or during its last software upgrade.

The following pages give a basic idea of the menu structure and how you navigate through the menu system to the different programming levels. Some changes from these specific displays may be present in your installation.

CONTROL KEYS

STATUS MENU-FX

Inv Hot Key

INV

```

INVERTER CONTROL
currently:      ON
OFF SRCH ON OK
    
```

AC IN Hot Key

AC IN

```

AC INPUT CONTROL
currently: DROP
DROP USE      OK
    
```

AC IN *second press*

```

GEN START CONTROL
currently:  MAN-OFF
OFF AUTO ON  OK
    
```

AC IN *third press*

```

CHARGER CONTROL
currently:  OFF
OFF AUTO      OK
    
```

AC IN *fourth press*

```

CHARGER MODE CONTROL
Global charger mode
BULK EQ       OK
    
```

Summary Screens

```

MAIN-----
6:54:42P
SUM STATUS SETUP ADV
    
```

```

DC<>AC. . . . . 0.0kW
AC Load . . . . .
Buying . . . . .
Battery . . . . . 25.6V
    
```

```

-----
MX CHARGER. . . . .
Battery . . . . . 25.6V
    
```

MODES

```

MAIN-----
6:54:42PM
SUM STATUS SETUP ADV
    
```

```

STATUS-----
choose product:
FX MX
    
```

```

STATUS/FX/PAGE1-----
choose category:
MODES METER BATT PG2
    
```

```

STATUS/FX/MODE---P00
inv control:  ON
CHANGE
DOWN STAT MODE PORT
    
```

```

INVERTER CONTROL
currently:  ON
OFF SRCH ON  OK
    
```

```

STATUS/FX/MODE---P00
inv control:  ON
CHANGE
DOWN STAT MODE PORT
    
```

```

STATUS/FX/MODE---P00
ac in control: USE
CHANGE
DOWN UP  MODE PORT
    
```

```

AC INPUT CONTROL
currently:  USE
DROP USE    OK
    
```

```

STATUS/FX/MODE---P00
ac in control: USE
CHANGE
DOWN UP  MODE PORT
    
```

```

STATUS/FX/MODE---P00
chr control:  AUTO
CHANGE
DOWN UP  MODE PORT
    
```

```

CHARGER CONTROL
currently:  AUTO
OFF AUTO   OK
    
```

```

STATUS/FX/MODE---P00
chr control:  AUTO
CHANGE
DOWN UP  MODE PORT
    
```

```

STATUS/FX/MODE---P00
aux control:  AUTO
CHANGE
DOWN UP  MODE PORT
    
```

```

AUX OUTPUT CONTROL
currently:  AUTO
OFF AUTO ON  OK
    
```

MODES cont.

```

STATUS/FX/MODE---P00
aux control:  AUTO
CHANGE
DOWN UP  MODE PORT
    
```

```

STATUS/FX/MODE---P00
eq control:  NO
CHANGE
UP  MODE PORT
    
```

```

EQUALIZE CONTROL
eq enabled:  NO
STOP START  OK
    
```

METERS

```

MAIN-----
6:54:42P
SUM STATUS SETUP ADV
    
```

```

STATUS-----
choose product:
FX MX
    
```

```

STATUS/FX/PAGE1-----
choose category:
MODES METER BATT PG2
    
```

```

MODE: SILENT P00
inv 0.0kw zer 0.0kw
chg 0.0kw buy 0.0kw
DOWN STATUS PORT
    
```

```

STATUS/FX/METERS-P00
output 122 vac
voltage
DOWN UP TOP PORT
    
```

```

STATUS/FX/METERS-P00
input 122 vac
voltage
DOWN UP TOP PORT
    
```

```

STATUS/FX/METERS-P00
inverter 0.0 aac
current
DOWN UP TOP PORT
    
```

```

STATUS/FX/METERS-P00
charger 0.0 aac
current
DOWN UP TOP PORT
    
```

```

STATUS/FX/METERS-P00
input 0.0 aac
current
DOWN UP TOP PORT
    
```

```

STATUS/FX/METERS-P00
sell 0.0 aac
current
DOWN UP TOP PORT
    
```

cont. on next page

STATUS MENU--FX

METERS cont

STATUS/FX/METERS--P00
FX firmware 50
revision
DOWN UP TOP PORT

STATUS/FX/METERS----
end of meter menu
UP TOP STATUS

BATTERY

MAIN-----
6:54:42P
SUM STATUS SETUP ADV

STATUS-----
choose product:
FX MX

STATUS/FX/PAGE1-----
choose category:
MODES METER BATT PG2

STATUS/FX/BATT---P00
battery 25.0 vdc
actual
DOWN STATUS PORT

STATUS/FX/BATT---P00
battery 25.0 vdc
temp compensated
DOWN UP TOP PORT

STATUS/FX/BATT---P00
absorb 28.8 vdc
setpoint
DOWN UP TOP PORT

STATUS/FX/BATT---P00
absorb 01.5 hrs
time remaining
DOWN UP TOP PORT

STATUS/FX/BATT---P00
float 26.8 vdc
setpoint
DOWN UP TOP PORT

STATUS/FX/BATT---P00
float 00.8 hrs
time remaining
DOWN UP TOP PORT

STATUS/FX/BATT---P00
refloat 25.0 vdc
setpoint
DOWN UP TOP PORT

STATUS/FX/BATT---P00
equalize 28.8 vdc
setpoint
DOWN UP TOP PORT

BATTERY cont

STATUS/FX/BATT---P00
equalize 02.0 hrs
time remaining
DOWN UP TOP PORT

STATUS/FX/BATT---P00
batt temp. 255
(not in degree C/F)
DOWN UP TOP STATUS

STATUS/FX/BATT-----
end of battery menu
UP TOP STATUS

ERRORS

MAIN-----
6:54:42P
SUM STATUS SETUP ADV

STATUS-----
choose product:
FX MX

STATUS/FX/PAGE1-----
choose category:
MODES METER BATT PG2

STATUS/FX/PAGE2-----
choose category:
PG1 ERROR WARN PG3

STATUS/FX/ERROR--P00
low ac output NO
voltage
DOWN STATUS PORT

STATUS/FX/ERROR--P00
stacking NO
error detected
DOWN UP TOP PORT

STATUS/FX/ERROR--P00
inverter NO
overtemp
DOWN UP TOP PORT

STATUS/FX/ERROR--P00
low battery NO
voltage
DOWN UP TOP PORT

STATUS/FX/ERROR--P00
phase loss NO
error
DOWN UP TOP PORT

STATUS/FX/ERROR--P00
high battery NO
error
DOWN UP TOP PORT

ERRORS cont

STATUS/FX/ERROR--P00
ac output NO
shorted
DOWN UP TOP PORT

STATUS/FX/ERROR--P00
ac output NO
backfeed
DOWN UP TOP PORT

STATUS/FX/ERROR-----
end of error menu
UP TOP STATUS

WARNINGS

MAIN-----
6:54:42P
SUM STATUS SETUP ADV

STATUS-----
choose product:
FX MX

STATUS/FX/PAGE1-----
choose category:
METER BAT ERROR PG2

STATUS/FX/PAGE2-----
choose category:
PG1 ERROR WARN PG3

STATUS/FX/WARN---P00
ac in freq NO
to high
DOWN STATUS PORT

STATUS/FX/WARN---P00
ac in freq NO
to low
DOWN UP TOP PORT

STATUS/FX/WARN---P00
ac in voltage NO
to high
DOWN UP TOP PORT

STATUS/FX/WARN---P00
ac in voltage NO
to low
DOWN UP TOP

STATUS/FX/WARN---P00
ac input NO
current exceeds max
DOWN UP TOP PORT

STATUS/FX/WARN---P00
temperature NO
sensor fault
DOWN UP TOP PORT

cont. on next page

STATUS MENU--FX

WARNINGS cont

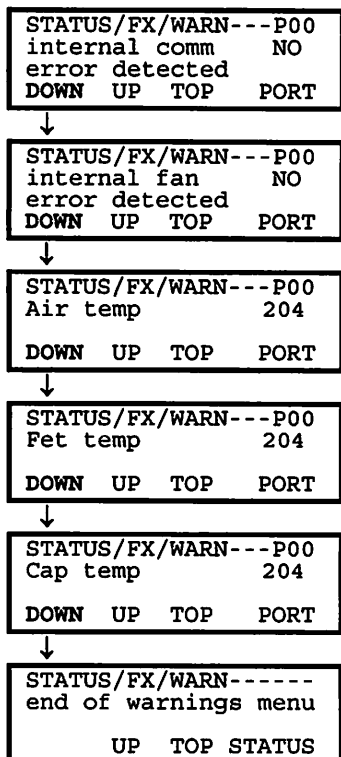

DISCONNECT REASONS

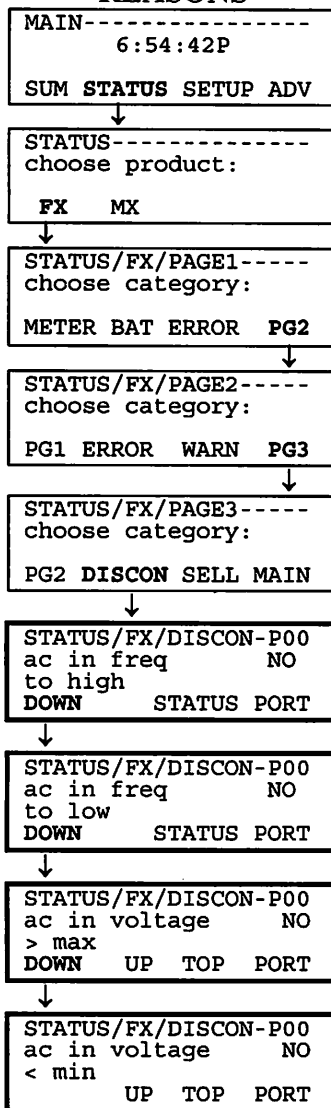

SELL

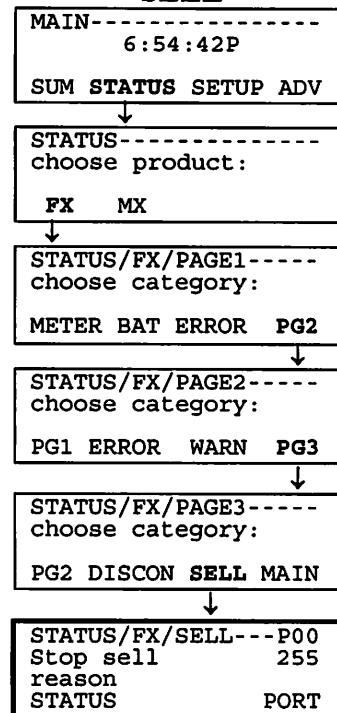

MAIN MENU SHORTCUT

Pressing the left two keys on the MATE at the same time from anywhere in the menu system takes you to the MAIN menu

STATUS MENU--MX

MODES

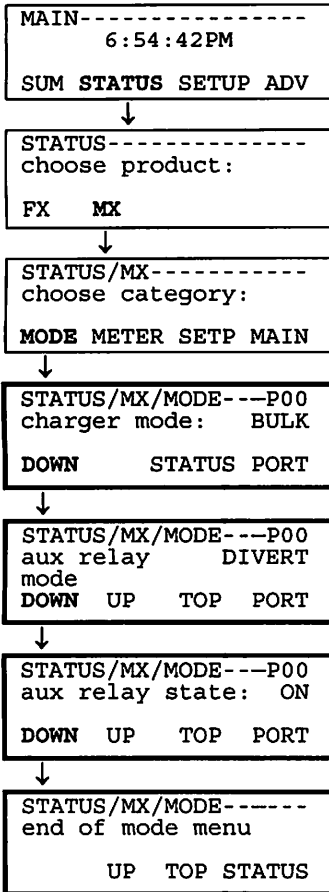

METERS

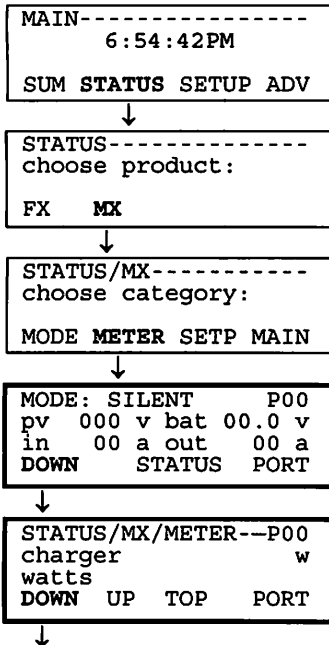

METERS cont

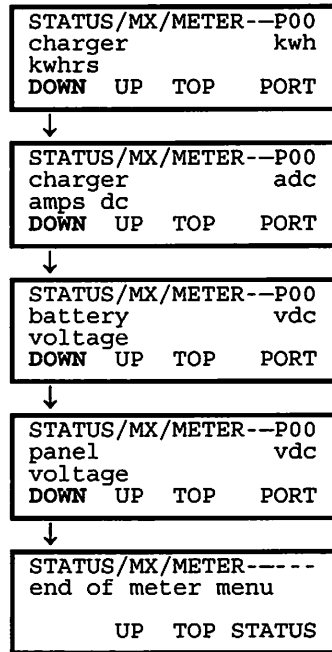

SETPOINTS

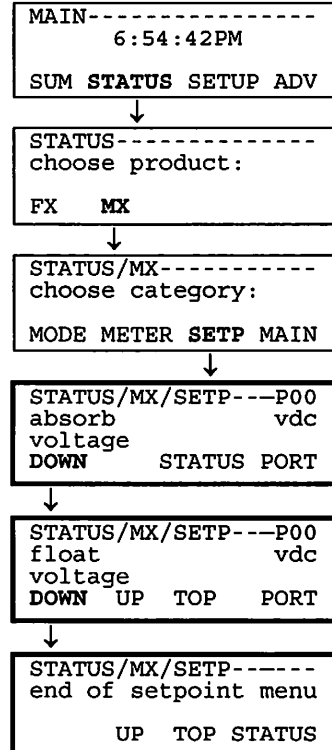

MAIN MENU SHORTCUT

Pressing the left two keys on the MATE at the same time from anywhere in the menu system takes you to the MAIN menu

SETUP MENU--FX

SEARCH

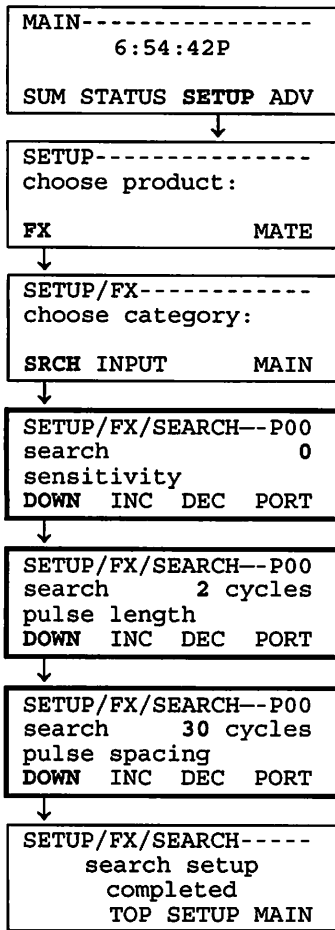

INPUT

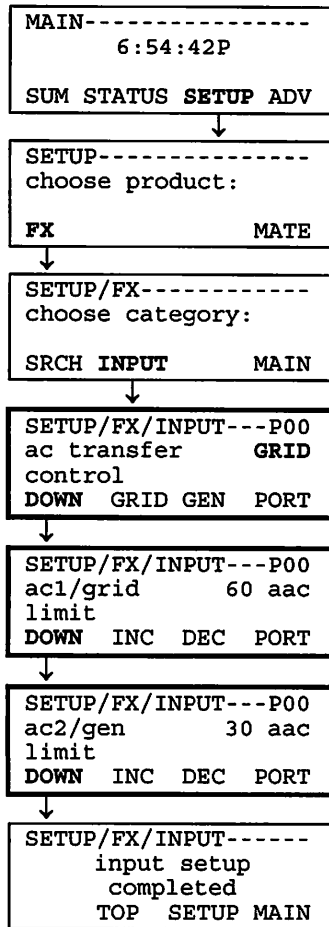

MAIN MENU SHORTCUT

Pressing the left two keys on the MATE at the same time from anywhere in the menu system takes you to the MAIN menu

SETUP MENU--MATE

MATE

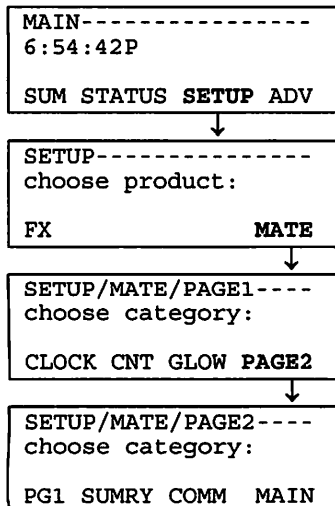

DATE / TIME

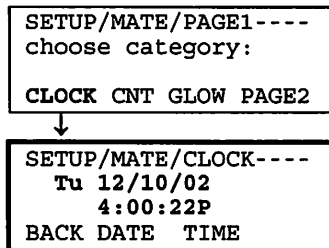

BACKLIGHT

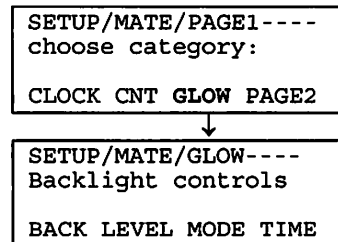

CONTRAST

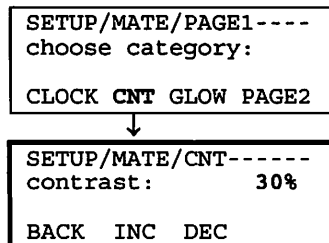

SETUP MENU--MATE

SUMMARY

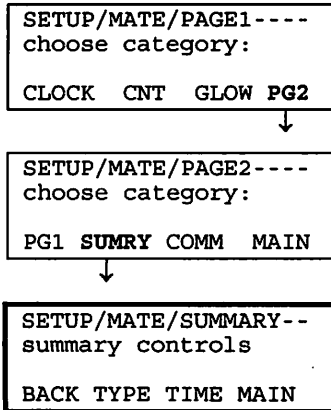

COMM

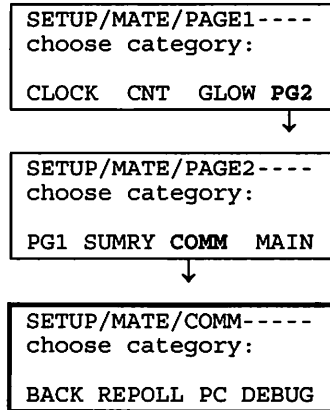

MAIN MENU SHORTCUT

Pressing the left two keys on the MATE at the same time from anywhere in the menu system takes you to the MAIN menu

ADVANCED MENU--FX

INVERTER

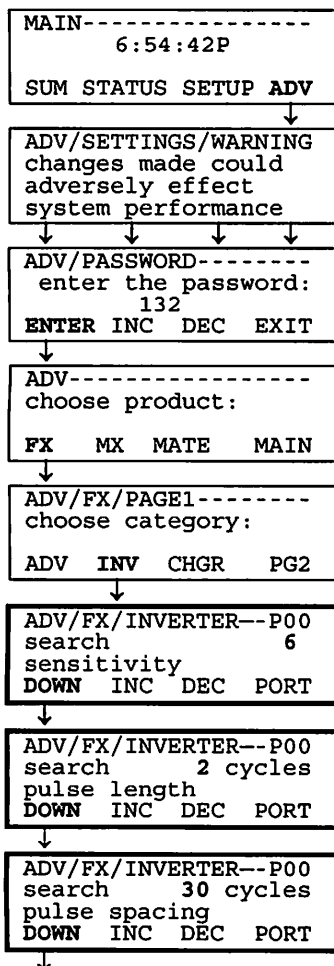

INVERTER cont

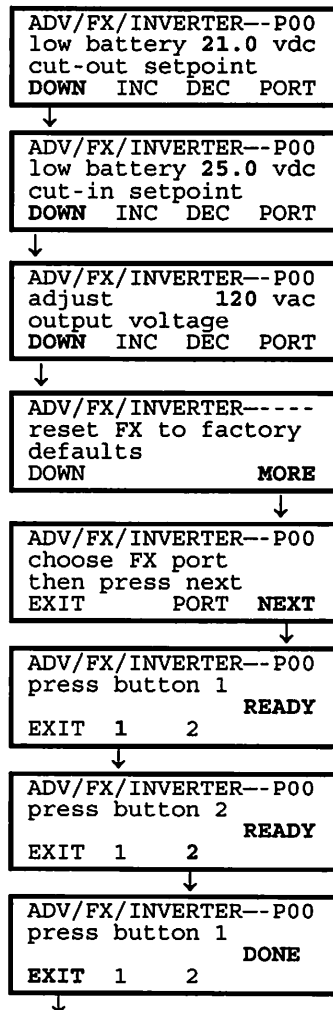

INVERTER cont

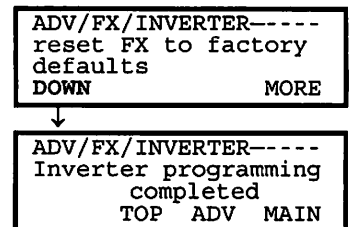

CHARGER

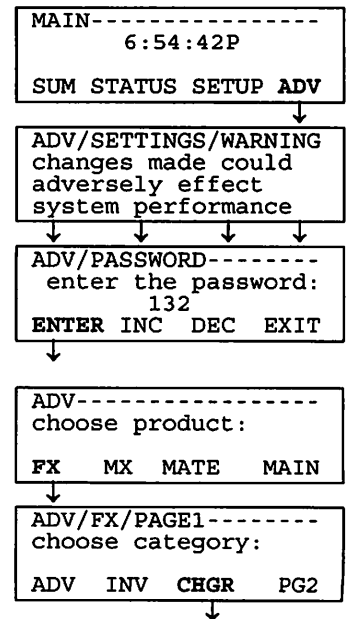

cont. on next page

ADVANCED MENU—FX

CHARGER cont

ADV/FX/CHARGER---P00
charger 12.0 aac
limit
DOWN INC DEC PORT

ADV/FX/CHARGER-----
absorb 28.8 vdc
setpoint
DOWN INC DEC PORT

ADV/FX/CHARGER---P00
absorb 02.0 hrs
time limit
DOWN INC DEC PORT

ADV/FX/CHARGER---P00
float 26.8 vdc
setpoint
DOWN INC DEC PORT

ADV/FX/CHARGER---P00
float 00.5 hrs
time period
DOWN INC DEC PORT

ADV/FX/CHARGER---P00
refloat 25.0 vdc
setpoint
DOWN INC DEC PORT

ADV/FX/CHARGER---P00
equalize 28.8 vdc
setpoint
DOWN INC DEC PORT

ADV/FX/CHARGER---P00
equalize 02.0 hrs
time period
DOWN INC DEC PORT

ADV/FX/CHARGER-----
Charger programming
compelcted
TOP ADV MAIN

GRID

MAIN-----
6:54:42P
SUM STATUS SETUP ADV

ADV/SETTINGS/WARNING
changes made could
adversely effect
system performance

ADV/PASSWORD-----
enter the password:
132
ENTER INC DEC EXIT

ADV-----
choose product:
FX MX MATE MAIN

ADV/FX/PAGE1-----
choose category:
ADV INV CHGR PG2

ADV/FX/PAGE2-----
choose category:
ADV GRID GEN PG2

ADV/FX/GRID-----P00
ac input 00.5 min
connect delay
DOWN INC DEC PORT

ADV/FX/GRID-----P00
ac1/grid 100 vac
lower limit
DOWN INC DEC PORT

ADV/FX/GRID-----P00
ac1/grid 140 vac
upper limit
DOWN INC DEC PORT

ADV/FX/GRID-----P00
ac1/grid 60.0 aac
input limit
DOWN INC DEC PORT

ADV/FX/GRID-----P00
ac1/grid 3 cycles
transfer delay
DOWN INC DEC PORT

ADV/FX/GRID-----P00
ac1/grid ON
hot standby
DOWN OFF ON PORT

ADV/FX/GRID-----
GRID programming
completed
TOP ADV MAIN

GEN

MAIN-----
6:54:42P
SUM STATUS SETUP ADV

ADV/SETTINGS/WARNING
changes made could
adversely effect
system performance

ADV/PASSWORD-----
enter the password:
132
ENTER INC DEC EXIT

ADV-----
choose product:
FX MX MATE MAIN

ADV/FX/PAGE1-----
choose category:
ADV INV CHGR PG2

ADV/FX/PAGE2-----
choose category:
PG1 GRID GEN PG3

ADV/FX/GEN-----P00
ac input 00.5 min
connect delay
DOWN INC DEC PORT

ADV/FX/GEN-----P00
ac2/gen 100 vac
lower limit
DOWN INC DEC PORT

ADV/FX/GEN-----P00
ac2/gen 140 vac
upper limit
DOWN INC DEC PORT

ADV/FX/GEN-----P00
ac2/gen 60.0 aac
input limit
DOWN INC DEC PORT

ADV/FX/GEN-----P00
ac2/gen 3 cycles
transfer delay
DOWN INC DEC PORT

ADV/FX/GEN-----P00
ac2/gen OFF
support
DOWN OFF ON PORT

ADV/FX/GEN-----
GEN programming
completed
TOP ADV MAIN

AUX OUTPUT

MAIN-----
6:54:42P
SUM STATUS SETUP ADV

ADV/SETTINGS/WARNING
changes made could
adversely effect
system performance

ADV/PASSWORD-----
enter the password:
132
ENTER INC DEC EXIT

ADV-----
choose product:
FX MX MATE MAIN

ADV/FX/PAGE1-----
choose category:
ADV INV CHGR PG2

ADV/FX/PAGE2-----
choose category:
PG1 GRID GEN PG3

cont on next page

AUX OUTPUT cont

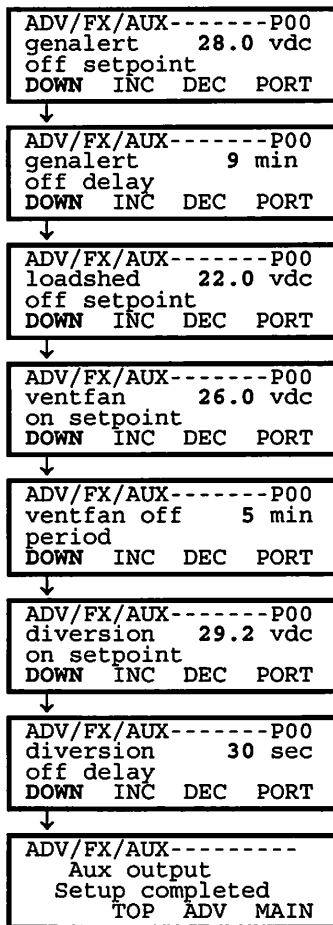
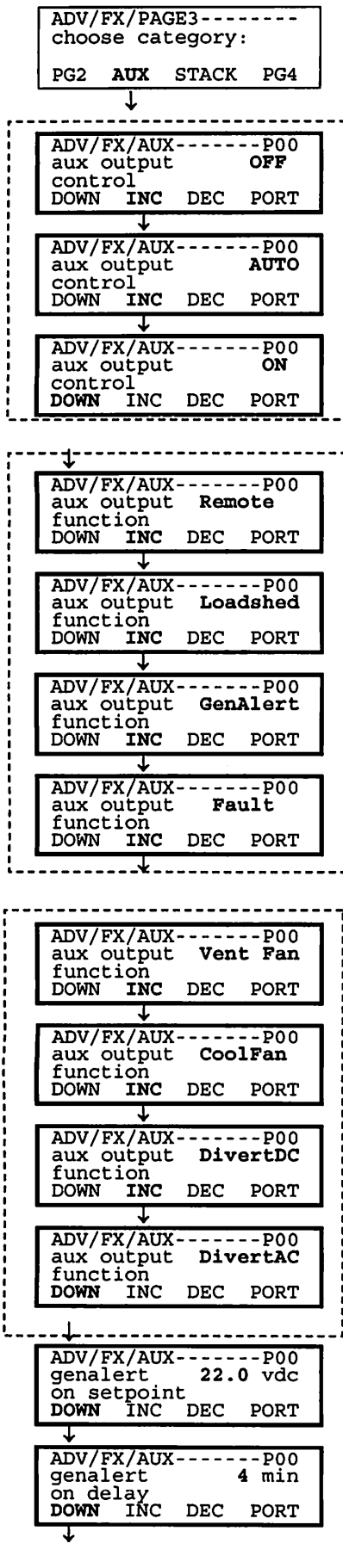

STACKING

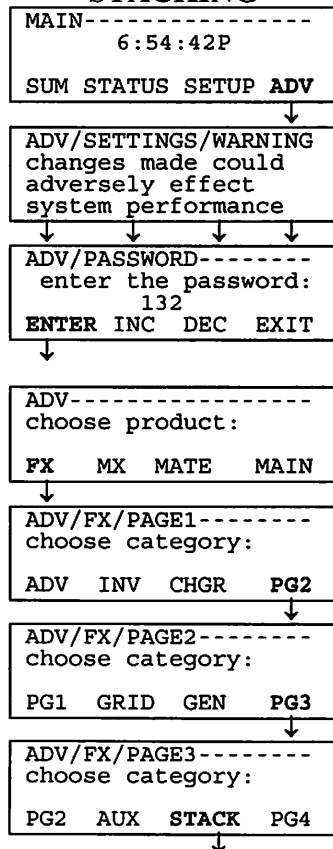

STACKING cont

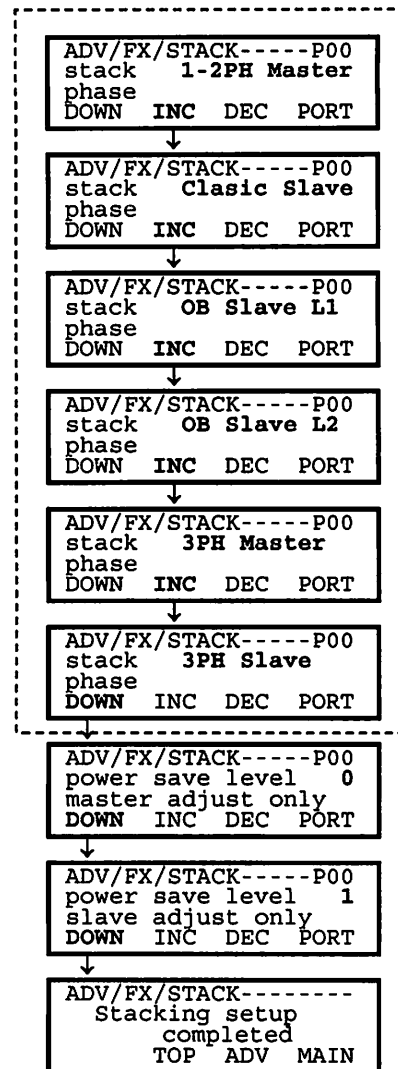

SELL

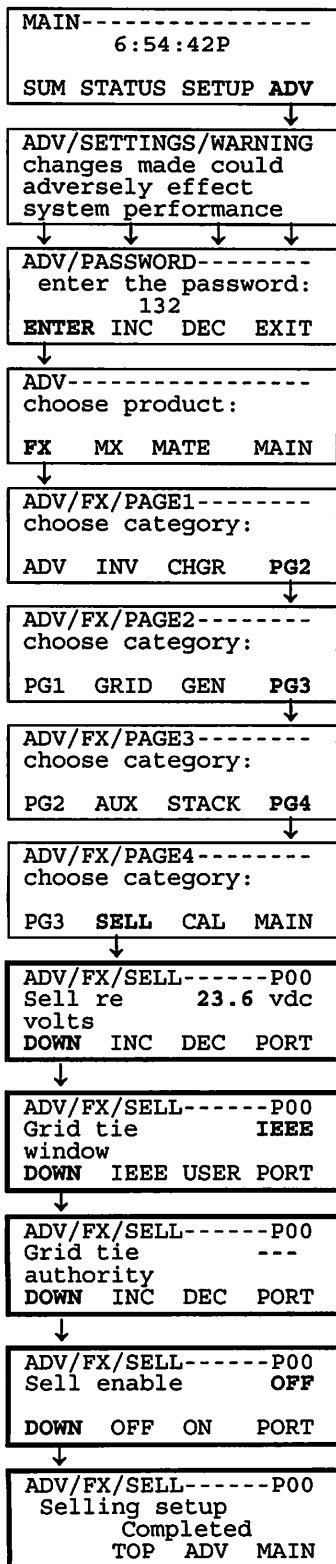

CAL

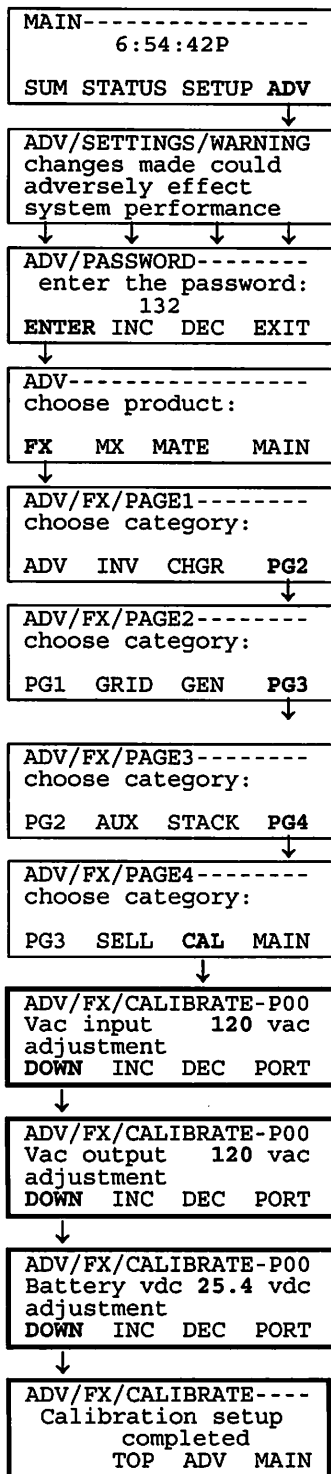

MAIN MENU SHORTCUT

*Pressing the left two keys on the MATE
at the same time from anywhere in the
menu system takes you to the MAIN menu*

ADVANCED MENU--MX

AUX

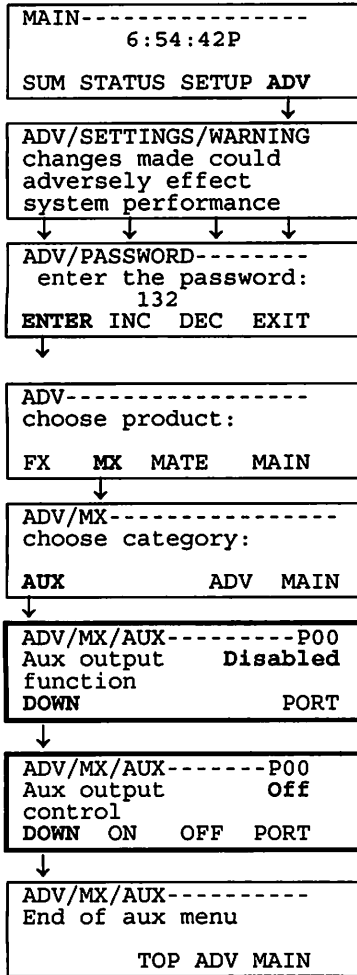

MAIN MENU SHORTCUT

*Pressing the left two keys on the MATE
at the same time from anywhere in the
menu system takes you to the MAIN menu*

ADVANCED MENU--MATE

AGS SETUP

QUIET TIME

VOLTAGE START

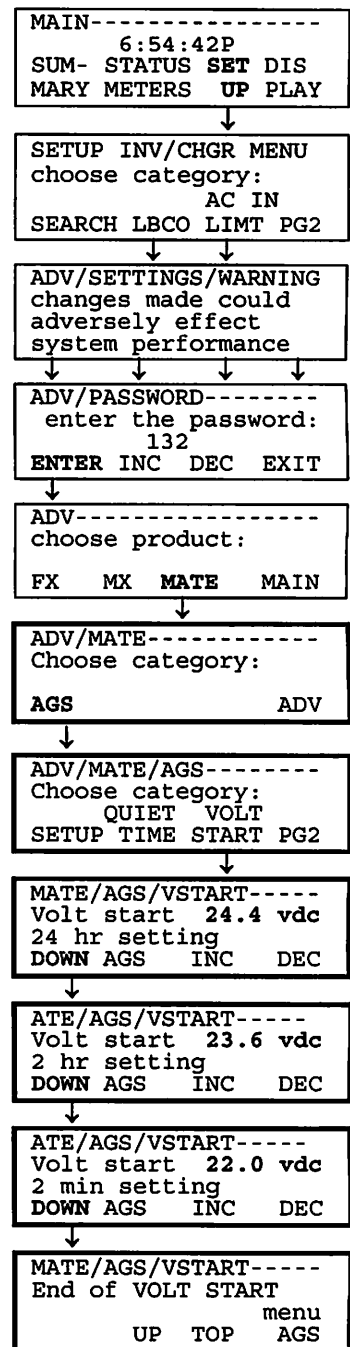
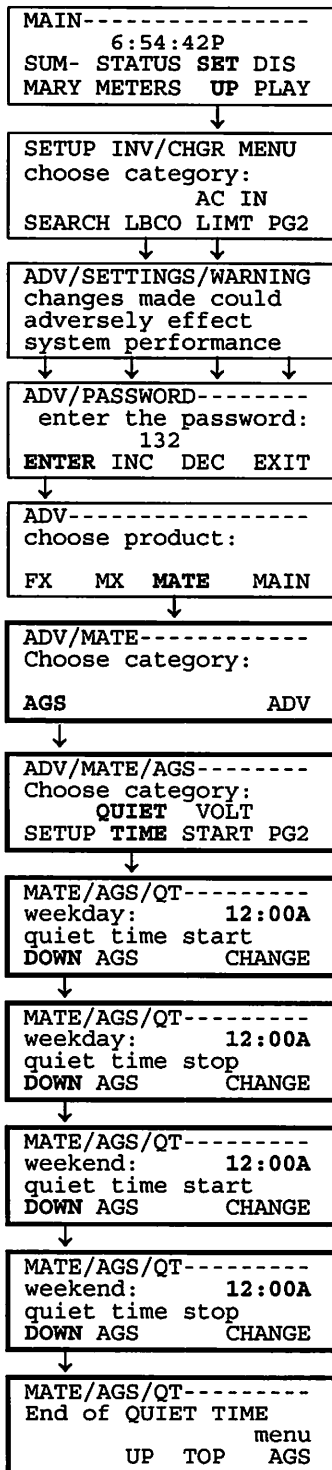
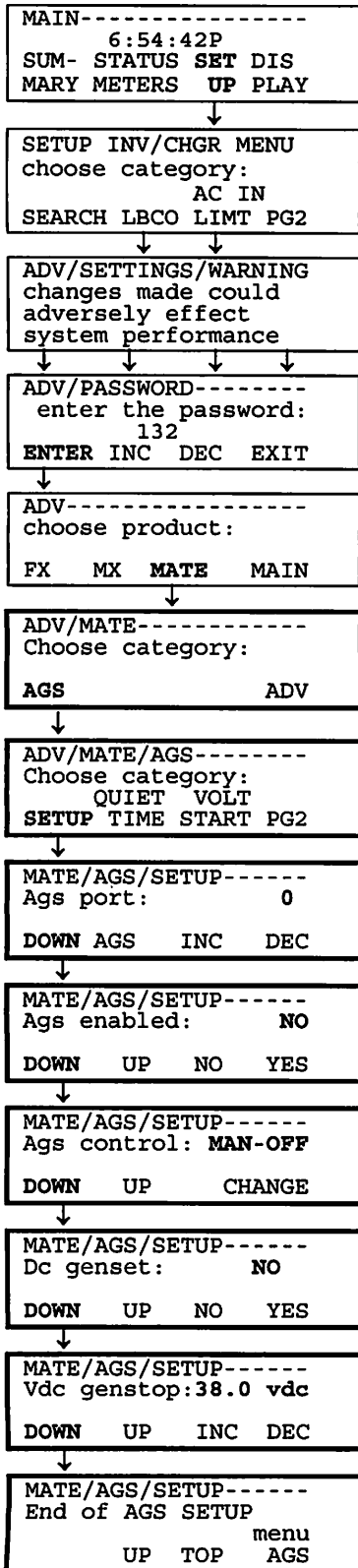

LOAD START

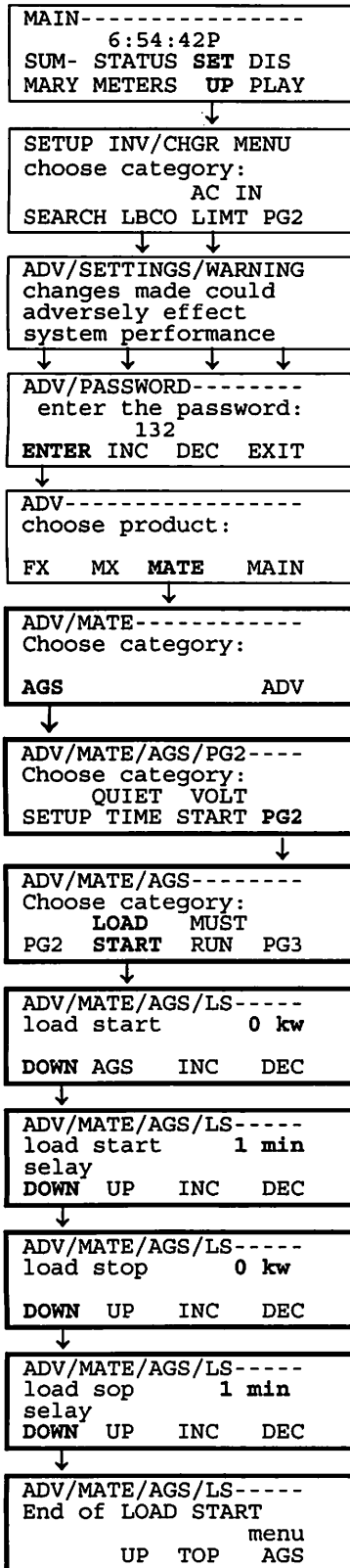

MUST RUN

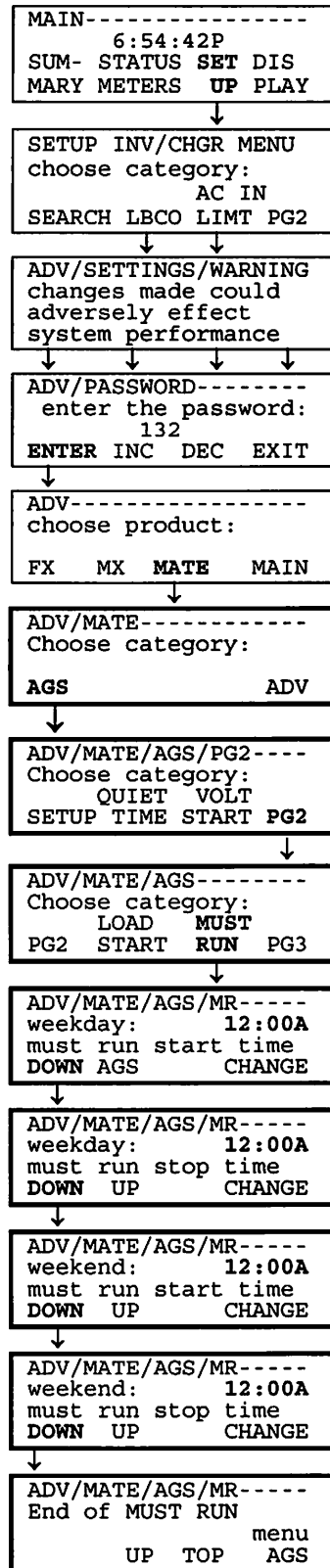

EXERCISE

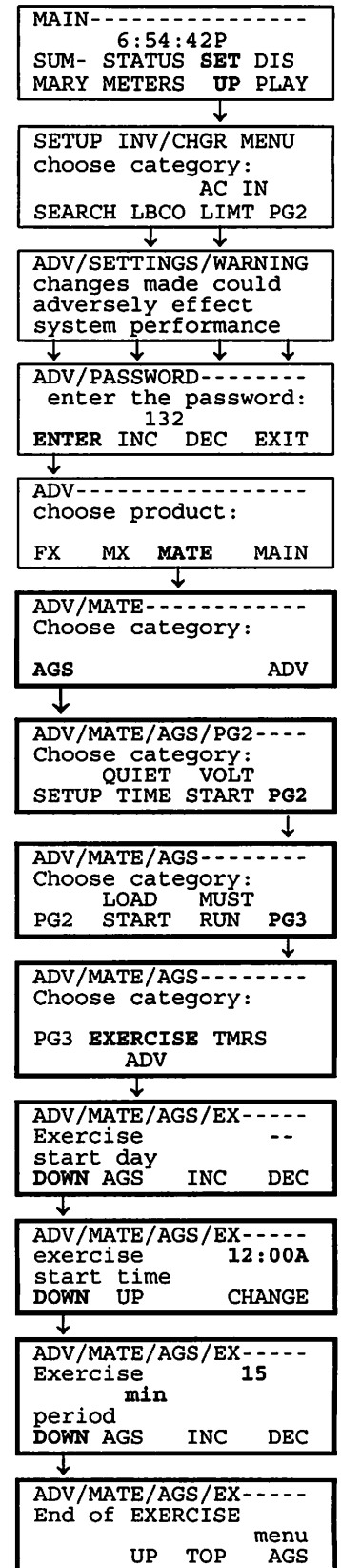

TIMERS

TIMERS cont.

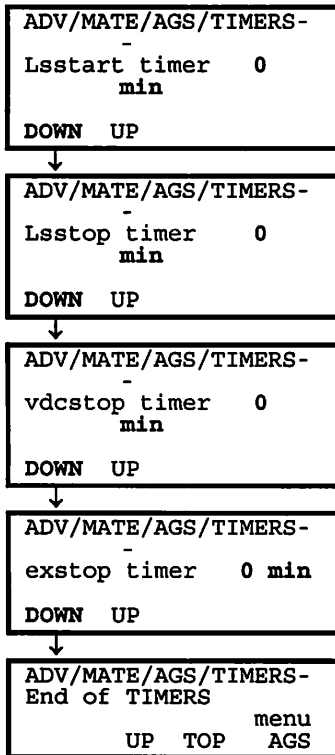
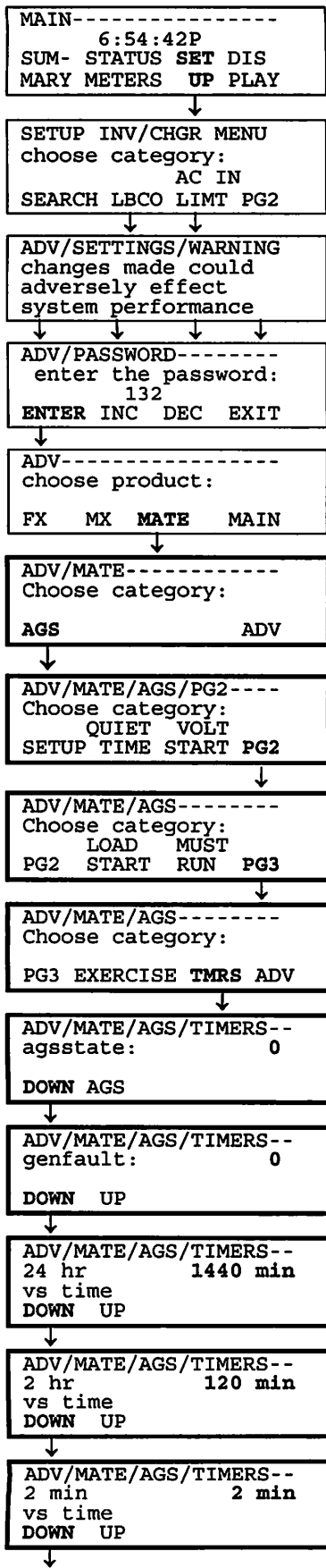

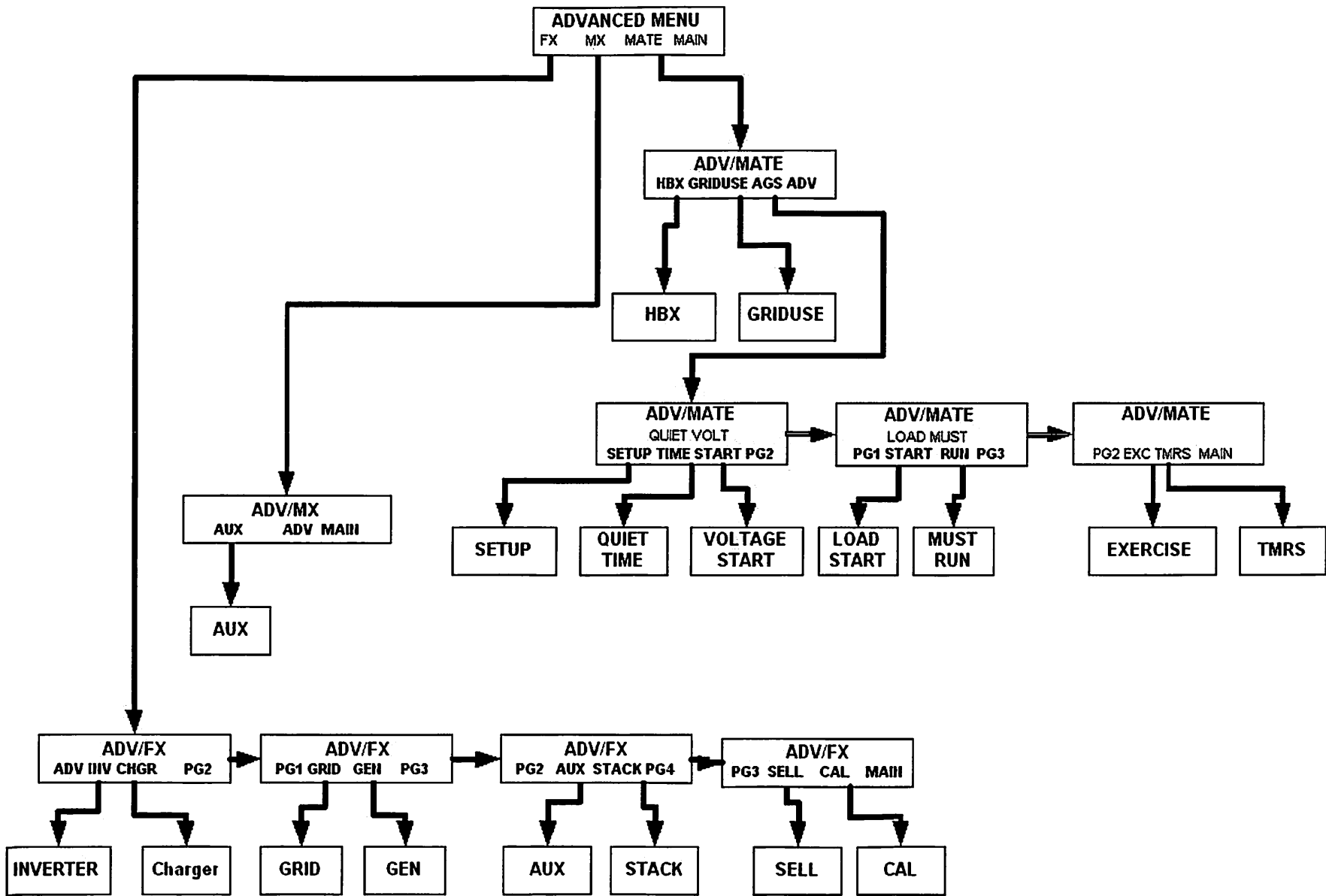

7.0 Troubleshooting

MATE does not power-up

The OutBack MATE is powered by the OutBack product that it is connected to. Make sure that all OutBack Products are powered-up and operating correctly before connecting the MATE. Check or replace the CAT5 cables running from the MATE to the OutBack product.

MATE does not find a Device

Make sure that all OutBack Products are powered-up and operating correctly before connecting the MATE. Check or replace the CAT5 cables running from the MATE to the OutBack product.

If a HUB is being used, make sure no OutBack products have been moved, unplugged, or added. If they have, follow the instructions in [MATE Setup Communications Options](#) to REPOLL for moved or new devices.

MATE does not display the correct meter or setting.

Make sure that all OutBack Products are powered-up and operating correctly before connecting the MATE. Check or replace the CAT5 cables running from the MATE to the OutBack product.

If a HUB is being used, make sure no OutBack products have been moved or unplugged. If they have, follow the instructions in [MATE Setup Communications Options](#) to REPOLL for moved or new devices.

MATE will not EQ my system when I use the EQ function under the <ACIN> button.

Older FXs and MXs with a newer MATE will not be able to utilize this system wide command. FXs that do not respond to this command can have an EQ cycle started by using the EQ start function located in the STATUS/FX/MODE menu. From the Main screen press <STATUS>, <FX>, <MODES>. Continue to press <DOWN> until you see the EQ function. If a HUB is used, FXs must have an EQ cycle start individually for each FX on the HUB (Use the <PORT> button to cycle through the available FXs).

MATE displays a 'COMM ERROR'

If the MATE receives too many interrupted or corrupt communications with OutBack products attached to the HUB, it will display a 'COMM ERROR' screen.

Choosing 'VIEW DEBUG' takes you to a screen that lists all ports and accumulated errors. Any Port experiencing errors can be found by the error count after the Port number.

In the example to the right, Port 4 has a large number of errors detected (04:025 means Port 4: showing 25 errors).

00:000	01:000	02:000
03:000	04:025	05:000
06:000	07:000	08:000
09:000	10:000	2M:000

Pressing any key will take you to the SETUP/MATE/COMM screen, which will allow the error counts to be reset using the 'RSET' button, the Debug screen can be redisplayed by using the 'VIEW' button, or user can get back to the SETUP menu by using the 'BACK' button.

Use the information on the Debug screen to locate the problem device. Make sure that it's DC breaker is on, and that it is operating correctly. Check or replace CAT5 cables running from the HUB to that device.

OutBack Power Systems

Two Year Limited Warranty

OutBack Power Systems Inc. warrants that the products it manufacturers will be free from defects in materials and workmanship for a period of two (2) years subject to the conditions set forth below.

The limited warranty is extended to the original user and is transferable. The limited warranty term begins on the date of invoice to the original user of the product. The limited warranty does not apply to any product or part thereof damaged by a) alteration or disassembly, b) accident or abuse, c) corrosion, d) lightning, e) reverse polarity, f) repair or service provided by an unauthorized repair facility, g) operation or installation contrary to instructions pertaining to the product.

OutBack Power Systems' liability for any defective product or any part thereof shall be limited to the repair or replacement of the product, at OutBack Power Systems' discretion. OutBack Power Systems does not warrant or guarantee the workmanship performed by any person or firm installing its products.

THIS LIMITED WARRANTY GIVES YOU SPECIFIC LEGAL RIGHTS, AND YOU MAY ALSO HAVE OTHER RIGHTS THAT VARY FROM STATE TO STATE (OR JURISDICTION TO JURISDICTION). OUTBACK POWER SYSTEMS' RESPONSIBILITY FOR MALFUNCTIONS AND DEFECTS IN HARDWARE IS LIMITED TO REPAIR AND REPLACEMENT AS SET FORTH IN THIS LIMITED WARRANTY STATEMENT. ALL EXPRESS AND IMPLIED WARRANTIES FOR THE PRODUCT, INCLUDING BUT NOT LIMITED TO ANY IMPLIED WARRANTIES OF AND CONDITIONS OF MERCHANTABILITY AND FITNESS FOR A PARTICULAR PURPOSE, ARE LIMITED IN DURATION TO THE LIMITED WARRANTY PERIOD SET FORTH ABOVE AND NO WARRANTIES, WHETHER EXPRESS OR IMPLIED, WILL APPLY AFTER SUCH PERIOD. SOME STATES (OR JURISDICTIONS) DO NOT ALLOW LIMITATIONS ON HOW LONG AN IMPLIED WARRANTY LASTS, SO THE ABOVE LIMITATION MAY NOT APPLY TO YOU.

OUTBACK POWER SYSTEMS DOES NOT ACCEPT LIABILITY BEYOND THE REMEDIES SET FORTH IN THIS LIMITED WARRANTY STATEMENT OR LIABILITY FOR INCIDENTAL OR CONSEQUENTIAL DAMAGES, INCLUDING WITHOUT LIMITATION ANY LIABILITY FOR PRODUCTS NOT BEING AVAILABLE FOR USE. SOME STATES (OR JURISDICTIONS) DO NOT ALLOW THE EXCLUSION OR LIMITATION OF INCIDENTAL OR CONSEQUENTIAL DAMAGES, SO THE ABOVE EXCLUSION OR LIMITATION MAY NOT APPLY TO YOU.

During the two year period beginning on the invoice date, OutBack Power Systems will repair or replace products covered under this limited warranty that are returned to OutBack Power Systems' facility or to an OutBack Power Systems authorized repair facility, or that are repaired on site by an OutBack Power Systems authorized repair technician. To request limited warranty service, you must contact OutBack Power Systems at 360-435-6030 within the limited warranty period. If limited warranty service is required, OutBack Power Systems will issue a Return MATERIAL Authorization (RMA) Number. Mark the outside of the package with the RMA number and include a copy of the purchase invoice in the package. You must ship the products back to OutBack Power Systems in their original or equivalent packaging, prepay shipping charges, and insure the shipment or accept the risk of loss or damage during shipment. OutBack Power Systems will ship the repaired or replacement products to you freight prepaid if you use an address in the continental United States, where applicable. Shipments to other locations will be made freight collect.

REGISTER YOUR PRODUCTS!

Your purchase of an OutBack Power Systems product is an important investment. Registering your products will help us maintain the standard of excellence you expect from us in terms of performance, quality and reliability.

Please take a moment to register and provide us with some important information.

Name: _____

Address: _____

City, State, Zip Code: _____

Country: _____

Telephone Number: _____

E-mail: _____

Sold by: _____

Installer: _____

Purchase Date: _____

Model Number: _____

Serial Number: _____

Circle all that apply:

Off-Grid Installation

Residential Installation

North America Location

Utility Connected Installation

Commercial Installation

Other _____

EXTENDED WARRANTY APPLICATION

OutBack Power Systems offers an optional three year extension to the standard two year limited warranty. Purchase of extended warranty coverage is available on products listed below provided conditions shown are met. Extended warranty coverage must be purchased within 90 days of the original sale of the product covered.

PRODUCT	REQUIRED SURGE PROTECTION	EXTENDED WARRANTY COST
FX2024	AC Input; AC Output, DC Input	\$300.00
FX2048	AC Input; AC Output, DC Input	\$300.00
MX60	DC Input; DC Output	\$100.00
MATE	NA	\$50.00
HUB 4	NA	\$35.00
HUB 10	NA	\$50.00

<u>Product Covered</u>	<u>Serial Number</u>	<u>Quantity</u>	<u>Extended Warranty Cost</u>
_____	_____	_____	_____
_____	_____	_____	_____
_____	_____	_____	_____
			Total _____

Send check or money order payable to OutBack Power Systems. Include a completed copy of this application and send to:

OutBack Power Systems
 Extended Warranty Program
 19009 62nd Ave NE
 Arlington WA 98223 USA

Addendum for FX Series Inverter/Chargers

Inverters with the most current software can be connected in parallel or series with other similar inverters with previous software revisions, but it is recommended the inverter with the newest software operates as the MASTER.

All FX and VFX inverter/chargers incorporate the following operational changes as of 5-26-06:

► Search Functions

- The operating mode of the inverter (OFF / SEARCH / ON) is now remembered by the inverter when it is powered down (DC power removed). The inverter will return to the same mode it was in when DC power is reconnected to the inverter.
- The remote ON/OFF control switch system no longer allows selection of SEARCH mode. Only ON or OFF is now selectable via these terminals. The two terminals marked INVERTER and ON/OFF still must be connected via the provided jumper or a user-supplied switch in order for the inverter to operate. Operation of the battery charger and AC transfer switch is not affected by the ON/OFF status of the inverter – the charger and transfer switch will always operate when AC power is applied regardless of the inverter being turned ON or OFF.
- In Search Mode, the LED now blinks when the inverter is actually searching for a load and the inverter LED goes solid when a load is found.

► AC Output Voltage

- This remains at the full nominal VAC output level even when light loads are connected – previous software revisions dropped the AC output voltage level slightly when very small AC loads were being powered by the inverter.
- The AC output voltage level is adjustable and this programmed level is remembered when DC power is disconnected and then reapplied.
- Offers improved regulation when a transfer from an AC source to the inverter occurs, improving the ability of the inverter to keep sensitive AC loads operating when a utility outage occurs.

► AUX

- The AUX output over-current protection system is now improved and the system automatically resets after 10 seconds if an overload occurs.